

Numatic

Performance You Can Trust



2024 PRODUCT
CATALOGUE
UK EDITION



We make **better products** in a **better** way.

- We select materials and processes that are more sustainable, and manufacturing that has less impact.
- Our products are designed to be more efficient, reducing energy use and carbon impact.
- We make products that are reliable, serviceable and built to last.



“We continually review, refine and adapt our manufacturing processes to deliver even greater levels of sustainability throughout our product ranges.”

Chris Duncan
Chairman and Founder of Numatic International Ltd.

In 2024, our customers continue to grapple with a myriad of complex and pressing challenges. Elevating cleaning and hygiene standards for all, achieving heightened productivity, and making substantial strides towards the critical sustainability agenda remaining at the forefront of the cleaning industry. Addressing the needs of today and conquering the challenges of tomorrow requires professional cleaning solutions that deliver

Performance You Can Trust.



Head Office
Numatic International Limited
Chard, Somerset TA20 2GB
UNITED KINGDOM
Tel: 01460 68600
numatic.com

Contents	Page
Sustainability	
Sustainability Formula	4
Net Zero by 2035	5
Sustainability in Action	6
ReFlo Technology	6-7
charity: water	6-7
C Level Offsetting	6-7
Our Services	
ServiceCare, Numatic Hire	8
Digital Services: Nu-Assist, Nu-Design, Nu-Track	9
The Complete Cleaning Solution	10-11
CleanCare	
Bringing power, performance and reliability to our commercial cleaning product range.	12-33
CleanCare Kits	34-35
ProCare	
Advanced, professional cleaning for the collection and control of dust and hazardous substances.	36-41
ProCare Kits	42
FloorCare	
Providing innovative, reliable and effective floorcare solutions, even in the most demanding environments.	44-57
FloorCare Brushes/Pads & Accessories	58-61
VersaCare	
Raising cleaning standards and productivity with versatility, innovation and quality are at the core of our janitorial cleaning systems.	62-95

Building on Sustainability

The **NUMATIC SUSTAINABILITY FORMULA** is the foundation to all our product development and sustainable initiatives.

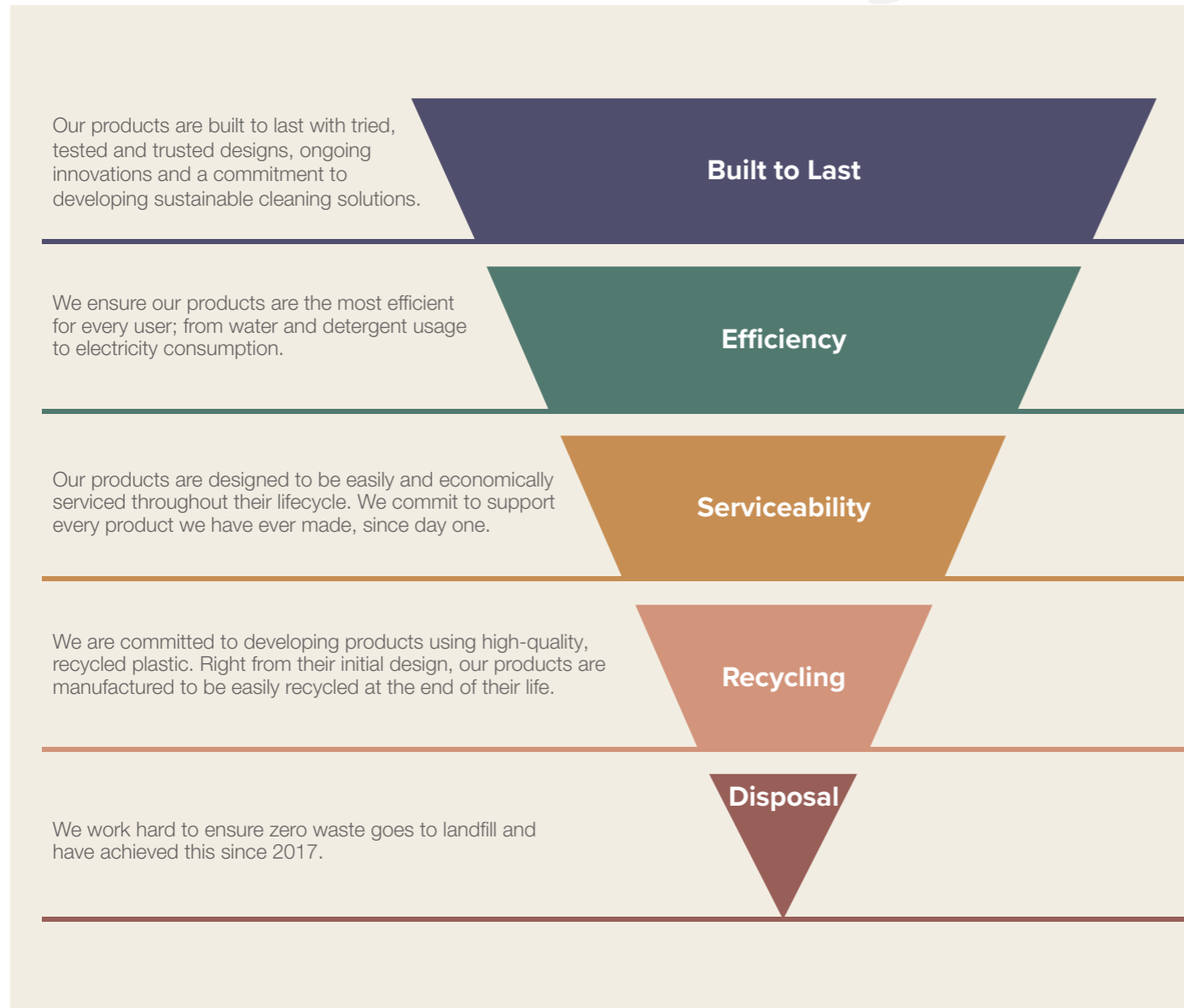

INTEGRATED SUSTAINABILITY

A sustainable approach is integrated throughout all of our operations, from design to manufacturing, to distribution and when in use. Our teams always strive to innovate and introduce even more sustainable manufacturing practices at our 42 acre site in Somerset, United Kingdom.

- Extensive Solar Investment
- Resource-Efficient Technologies
- Zero Waste to Landfill
- Sustainable Product Lifecycle
- LED Lighting

Net Zero by 2035

We recognise the need and demand for sustainable cleaning solutions and commit to initiatives across our business.

This includes becoming Net Zero by 2035 (for Scope 1 and 2) by setting incremental targets to keep us on track. We have also signed up to the Science Based Targets Initiative (SBTi), setting ambitious emissions reduction targets in line with the latest climate science.

While we work on reducing our emissions, we have taken additional measures to reduce our impact on the planet by carbon balancing our Scope 1 and 2 emissions through our trusted offsetting partner C Level.

2024

- 30%**
30% reduction in plastic packaging use (avg. KGs per unit) by end of 2022, and further 30% reduction by end of 2024.
- 10%**
Reduce CCA (Climate Change Agreement) Measured Electricity and Gas usage by 10%, under agreed CCA targets, by end of 2024.
- 10%**
Reduce non-recyclable waste by end of 2024.

2025

- 50%**
Increase use of recycled plastic in our 11" and 12" vacuum cleaners by 50%, by end of 2025.

We support the following **Sustainable Development Goals (SDGs)** of the United Nations:

3 GOOD HEALTH AND WELL-BEING	5 GENDER EQUALITY	6 CLEAN WATER AND SANITATION	9 INDUSTRY, INNOVATION AND INFRASTRUCTURE
10 REDUCED INEQUALITIES	11 SUSTAINABLE CITIES AND COMMUNITIES	12 RESPONSIBLE CONSUMPTION AND PRODUCTION	13 CLIMATE ACTION

PHASE 1 (2020-2023)
Collection of data surrounding our operations and carbon footprint

PHASE 2 (2023-2026)
Launch key initiatives and long-term goals for sustainability. In 2023, we committed to the Science Based Targets initiatives (SBTi)

PHASE 3 (2026-2029)
Scale up our initiatives and begin hitting some major targets

PHASE 4 (2029-2032)
Continue driving down emissions and gain a clear picture of how well we have fared globally in our endeavour to limit global warming. 42% emissions reduction across all scopes by 2030

PHASE 5 (2032-2035)
Ensure that all possible reductions have been made to secure Net Zero for Scope 1 and 2

2035
Scope 1 & 2 Net Zero
Scope 3 50% reduction

2045
Scope 3 75% reduction

2050 & Beyond
To reach **Net Zero** with 90% emissions reduction across all scopes, in line with SBTi 1.5°C emissions reduction pathway

Scope 1
Direct emissions produced by our company facilities and our company vehicles.

Scope 2
Indirect emissions from purchased electricity, steam, heating and cooling used for our own use.

Scope 3
Emissions covered by Scope 3 include our upstream and downstream operations.

Sustainability in Action

Achieving ambitious sustainability targets requires innovation, action and transparency. These initiatives move us forward in reaching our goals and leading the way in providing sustainable cleaning solutions for our customers.

Sustainability is broader than just reducing our carbon footprint. True sustainability is helping others to be sustainable in their everyday practices, ensuring the earth and its communities are cared for.



numatic.com/reflo

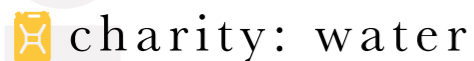

numatic.com/charitywater



numatic.com/sustainability



ReFlo Technology

Many of our products are engineered from our innovative, environmentally sustainable ReFlo Technology. We use the highest quality, recycled, post-industrial plastics, which are diverted from landfill.



OUR TEAMS ARE WORKING HARD TO EXPAND THE USE OF SUSTAINABLE MATERIALS ACROSS THE NUMATIC PRODUCT RANGE, WHEREVER POSSIBLE.

“Made from the highest quality, recycled plastic.”



The Bigger Picture

We've partnered with **charity: water** to provide water to communities and projects that need it the most. Through every purchase of a 244NX, we donate the equivalent of 5000L of water.

WORKING IN PARTNERSHIP WITH:



OUR INITIAL PROJECT TOOK PLACE IN MADAGASCAR, RECEIVING 100% OF THE DONATIONS.

“85 MILLION Litres of water funded since launch in 2021.”



58% of the population currently lack safe drinking water.

22.8 Million do not have a decent toilet.

8.5K of children under 5 die each year from diarrhoea.



Not Just Any Offsetting

We've been reducing our carbon footprint and offsetting global bag sales since 2020. We've partnered with a leading company in carbon offsetting innovation, C Level.

WORKING IN PARTNERSHIP WITH:



CARBON OFFSETTING GLOBAL BAG SALES SINCE 2020.

Our offsetting has drawn **11,350 tonnes** of CO2 down to Earth.

Projects we work with: CommuniTree, Trees for Global Benefit and Hadza Hunters.

“Numatic are working with us to take things even further, with more Carbon Balancing and looking at long term future goals.”

Daren Howarth | CEO & Founder C Level | change culture not climate



Our Services

We believe cleaning floors should be simple. It's about having the right equipment and right support; it really doesn't have to be more complicated than that. Simple cleaning, complete support.

Numatic ServiceCare

Cleaning Productivity Made Simple

We work with you at every turn, equipping you with all you need to maintain the highest cleaning standards.

For extra peace of mind, our full-service contracts cover you for any accidental damage or breakdowns, including two visits every year to service your machine.

- Servicing, Breakdown and Health Checks
- Digital Training, Maintenance and Guides
- Site Survey
- On-site Demo
- Refresher Operator Training
- Installation and Training

Get in touch...
numatic.co.uk/servicecare



Numatic Hire

Simplicity & Performance

The latest in professional cleaning equipment when you need it, direct from UK manufacturer.

Why Hire?

Hiring provides the ultimate flexibility with the latest cleaning equipment when you need it. Whether you need equipment for a week, 6 months or longer, we can flex around you.

- The Kit You Need, from Vacuums to Scrubber Dryers
- Short to Long-term Hire
- Switch Equipment if Needed
- ServiceCare Hire Cover Included
- Online and In-person Training*
- Option to Extend or Purchase

*In-person training for floor machines and scrubber dryers only.



For more information visit:
numatic.co.uk/hire

Digital Services

“Increase cleaning productivity with training and support at your fingertips.”

Numatic Nu-Assist

Increase Cleaning Productivity

The Nu-Assist App offers the benefit of online training through a simple, versatile and user-friendly solution, resulting in increased cleaning performance and productivity.

Scan me

Numatic Nu-Design

Bespoke Trolley Configurator

Nu-Design guides you through the product to configuration process, providing a visual output and configuration breakdown at each selection. The result; a reliable, functional and innovative cleaning system that meets your needs precisely.

Scan me

Numatic Nu-Track

Intelligent Fleet Management

Understand how, when and where your cleaning fleet is operating. Each asset automatically uploads status, location and usage reports to portal.

Scan me

The Complete Cleaning Solution

The UK's most comprehensive range of cleaning solutions, serving customers in all industries.



The Complete Cleaning Solution



Healthcare

Working closely with the Healthcare industry, raising cleaning standards and productivity.

Maintaining the highest standard of cleanliness and hygiene can be challenging, when working against the demands and pressures of a busy and diverse hospital, clinic or care home. You need cleaning equipment that meets your needs completely.



Hospitality

You don't get a second chance at a first impression.

In a demanding hospitality setting, where cleaning tasks are frequent and often intensive, durability is crucial. Numatic equipment is built to withstand continuous use and is designed to handle the challenges of commercial cleaning.



Education

Creating clean environments to work, learn and play.

Clean environments don't only deliver increased hygiene and safety, but also more positive, creative and comfortable environments for their users.



Construction

Robust and reliable equipment that has the power and performance to tackle whatever you throw at it.

Offering industrial-grade construction, advanced filtration to H-Class and equipment for every eventuality, ready to withstand the drops, bangs and scrapes that can happen frequently in the professional trade environment.



Logistics & Handling

Increasing cleaning performance and productivity for the Logistics & Handling industry around the clock.

When business is operating around the clock, it becomes even more important to have access to the right equipment for the right job. That equipment also needs to yield maximum productivity, delivering the results you need, when you need them, without fail.



Facilities Management

Collaborating with the Facilities Management industry delivering on high-quality, bespoke cleaning equipment for every sector.

Customers are seeking to overcome new challenges and solve problems; we have the solution. Whether you need to clean large shopping centres, busy supermarkets, compact store floors or open office spaces, our cleaning solutions deliver advanced cleaning results with maximum cleaning productivity.



CleanCare

CleanCare brings power, performance and reliability to our commercial cleaning product range.

CleanCare Contents

Eco ReFlo Range	14-15
ProLine Range	16-17
Numatic Quick	18-19
Sanitise Pro Sprayers	20
NX300 Pro Cordless Network	21-23
Mains Cable Backpacks	24
Steel Tops	25
MicroLine	25
Aircraft Line	26
Dry Big Capacity Vacuums	27
Wet or Dry Vacuums	28
Wet Vacuums	29
Wet & Dry Vacuums	30
Carpet Extraction Vacuums	31-33
CleanCare Kits & Accessories	34-35

14-15



ERP180

21



WBV370NX

Looking for Henry?

Visit: myhenry.co.uk

No Dust, No Mess, No Fuss

Scan me for more information

“No more mess with one-click dust-free emptying.”

See page 18-19 for more information on the Numatic Quick



Eco ReFlo Range

WORKS HARDER
LASTS LONGER
BUILT SMARTER

 **30% Energy Savings**

Using our 420W high-efficiency motor, the Eco ReFlo Range delivers powerful cleaning while reducing energy usage and cost.*1

 **Made from the highest quality, recycled plastic.**



- 1 Long-reach Hi-Vis 10m Cable
- 2 Cable Tidy and Carry Handle
- 3 Powerful Cleaning on Carpets and Hard-floors



Calculate Your Savings

Find out how much money you could save every year by switching to an Eco ReFlo Vacuum by visiting numatic.co.uk/ERP180 or scanning the QR Code



*1 Potential savings provided for guidance only, actual savings may differ dependent on usage and energy cost. Based on using 4 hours per day, over 260 days and £0.286kWh (as of 10/23 UK).

Annual Energy Usage

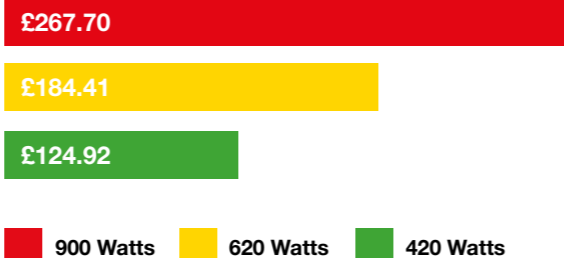

ERP180



- High-efficiency, economical cleaning
- Sustainably engineered from a minimum 45% recycled plastic, including accessories
- Carpets, hard-floors, cars, stairs, DIY
- Handy on-board tool storage
- Plugged cable
- 340x365x360mm (WxLxH)

8L Capacity	420W Motor	6.0KG Weight
Power 230V / AC 50/60Hz		
Power Cord 10.0m	Cleaning Range 26.4m	
Suction H ₂ O 1750mm	Kit AS0 (see page 34)	

EPR170*



- Equipped with our highest efficiency motor yet
- Carpets, hard-floors, cars, stairs, DIY
- Extra reach 12.5m cable with trouble-free rewind and additional on-board tool storage
- Sustainably engineered from a minimum 20% recycled plastic, including accessories
- Plugged cable
- Emptying with no dust and no mess
- 360x370x390mm (WxLxH)

7.2L Capacity	420W Motor	8.1KG Weight
Power 230V / AC 50/60Hz		
Power Cord 12.5m	Cleaning Range 31.4m	
Suction H ₂ O 1750mm	Kit AS0 (see page 34)	

EPR170 HEPA*



- Equipped with our highest efficiency motor yet
- Carpets, hard-floors, cars, stairs, DIY
- Certified HEPA13 filtration down to 0.3 microns at 99.95% efficiency
- Sustainably engineered from a minimum 20% recycled plastic, including accessories
- Plugged cable
- Emptying with no dust and no mess
- 360x370x390mm (WxLxH)

7.2L Capacity	420W Motor	8.3KG Weight
Power 230V / AC 50/60Hz		
Power Cord 12.5m	Cleaning Range 31.4m	
Suction H ₂ O 1750mm	Kit AS0 (see page 34)	

*Note: Not standard UK model, please contact your Numatic representative for information.

ProLine Range

The ProLine Plugged Vacuums are packed full of great features and provide powerful, professional cleaning technology from a high-efficiency, long-life motor in a choice of sizes.

PSP180

Cable Management & Plugged Cable



- Carpets, hard-floors, cars, stairs, DIY
- Handy on-board tool storage
- Professional accessory kit
- Plugged cable
- 340x365x360mm (WxLxH)

8L Capacity	620W Motor	6.0KG Weight
Power 230V / AC 50/60Hz		
Power Cord 10.0m	Cleaning Range 26.4m	
Suction H ₂ O 2300mm	Kit AS0 (see page 34)	

PSP240



- Carpets, hard-floors, cars, stairs, DIY
- Bumper for wall and door protection
- Handy on-board tool storage
- Plugged cable
- 360x370x415mm (WxLxH)

9L Capacity	620W Motor	8.0KG Weight
Power 230V / AC 50/60Hz		
Power Cord 10.0m	Cleaning Range 26.4m	
Suction H ₂ O 2300mm	Kit AS0 (see page 34)	

PSP370

Contractors' Choice



- Carpets, hard-floors, cars, stairs, DIY
- Bumper for wall and door protection
- Handy on-board tool storage
- Plugged cable
- 360x370x510mm (WxLxH)

15L Capacity	620W Motor	9.0KG Weight
Power 230V / AC 50/60Hz		
Power Cord 10.0m	Cleaning Range 26.4m	
Suction H ₂ O 2300mm	Kit AS0 (see page 34)	



“Professional, tough and versatile workhorse full of innovative features.”

PRP180



- Sustainably engineered from a minimum 45% recycled plastic, including accessories
- Carpets, hard-floors, cars, stairs, DIY
- Handy on-board tool storage
- Professional accessory kit
- Plugged cable
- 340x365x360mm (WxLxH)

8L Capacity	620W Motor	6.0KG Weight
Power 230V / AC 50/60Hz		
Power Cord 10.0m	Cleaning Range 26.4m	
Suction H ₂ O 2300mm	Kit AS73 (see page 34)	

PPR170*



- Easy replacement plugged cable system
- Bumper for wall and door protection
- Compact and convenient
- Emptying with no dust and no mess
- 360x370x390mm (WxLxH)

7.2L Capacity	620W Motor	8.1KG Weight
Power 230V / AC 50/60Hz		
Power Cord 12.5m	Cleaning Range 31.4m	
Suction H ₂ O 2300mm	Kit AS0 (see page 34)	

PPR170 HEPA*



- Easy replacement plugged cable system
- Bumper for wall and door protection
- Compact and convenient
- Emptying with no dust and no mess
- Certified HEPA13 filtration down to 0.3 microns at 99.95% efficiency
- 360x370x390mm (WxLxH)

7.2L Capacity	620W Motor	8.3KG Weight
Power 230V / AC 50/60Hz		
Power Cord 12.5m	Cleaning Range 31.4m	
Suction H ₂ O 2300mm	Kit AS0 (see page 34)	

NRV240



Contractors' Choice

- Carpets, hard-floors, cars, stairs, DIY
- Bumper for wall and door protection
- Handy on-board tool storage
- Emptying with no dust and no mess
- 360x370x415mm (WxLxH)

9.0L Capacity	620W Motor	9.0KG Weight
Power 230V / AC 50/60Hz		
Power Cord 12.5m	Cleaning Range 31.8m	
Suction H ₂ O 2300mm	Kit NS1 (see page 34)	

PPR240/ PPR370



Contractors' Choice

- Professional accessory kit
- Bumper for wall and door protection
- Long cleaning reach
- Emptying with no dust and no mess
- Plugged cable rewind
- 360x370x415mm (WxLxH) PPR240
- 360x370x510mm (WxLxH) PPR370

9L/15L Capacity 240/370	620W Motor	9.0/10.0KG Weight 240/370
Power 230V / AC 50/60Hz		
Power Cord 12.5m	Cleaning Range 31.4m	
Suction H ₂ O 2300mm	Kit AS0 (see page 34)	

PPT220/ PPT390



Handy Trolley Design

- Convenient, lift-off storage caddy
- Telescopic handle for ease of transit and storage
- Large rear wheels for ease of use on stairways
- Plugged cable rewind
- 355x355x615mm (WxLxH) PPT220
- 355x355x655mm (WxLxH) PPT390

9L/15L Capacity 220/390	620W Motor	12.3/12.6KG Weight 220/390
Power 230V / AC 50/60Hz		
Power Cord 12.5m	Cleaning Range 31.4m	
Suction H ₂ O 2300mm	Kit AS0 (see page 34)	

*Note: Not standard UK model, please contact your Numatic representative for information.

Numatic Quick

NUMATIC QUICK NQ100



- Up to 120mins of powerful cordless cleaning
- 1L pod capacity
- Advanced user comfort
- Interchangeable Lithium-Ion battery
- Clean dirt disposal
- 1 Year Warranty for Commercial use
- 240x270x1220mm (WxLxH)

1L Capacity	300W Motor	3.2KG Weight
Power 25.2V	Runtime 120mins (60mins per battery)	
Charge Time 2hrs 30mins (per battery)	Accessories (see page 34)	



Comes with 2 batteries; use one, charge one.



Bigger Capacity
Compacts dust inside the pod for more capacity than most leading vacuums.

Scent Pods



Battery Charge Indicator

Power Boost Light

Capacity Full Indicator

Power Brush Light

Henry Quick Pod

Quick Release

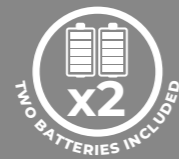

Visit: numatic.com/quick



“All the benefits of cordless cleaning with no dust, no mess, no fuss.”

POWERFUL
CORDLESS
DUST-FREE

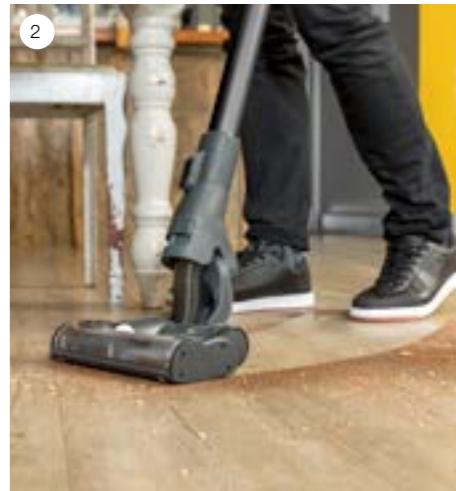

- 1 & 2 Motorised Brush Head
- 3 Ergonomic Handle for Extra Comfort
- 4 Handy Tools

Sanitise Pro Sprayers



HIGH-PRESSURE MISTING DISINFECTION SYSTEM

The Sanitise Pro Sprayers deliver 99.999%* efficiency in inactivating and destroying pathogens.

NSU370

- Simple to use with high-pressure quick drying mist
- Effective results every time by every user, across a wide range of environments
- High-performance pump and large capacity for extended use
- 360x370x510mm (WxLxH)

5L Capacity	45W Motor	7.2KG Weight
Max Pump Pressure 15Bar/217PSI		
Optimum Spray Distance 1.0m		
Droplet Size 65-75Microns		
Power Cord 10.0m	Cleaning Range 12.0m	
Flow 150ml/min	Hose Length 2.2m	



NX300 RSU150NX

- Simple to use with high-pressure quick drying mist
- Stay cleaning for longer with a 6 hour runtime and 60mins fast charge
- Effective results every time by every user, across a wide range of environments
- Part of NX300 Pro Cordless Network
- High-performance pump and large capacity for extended use
- 330x330x570mm (WxLxH)

5L Capacity	6HRS Battery Life	13.0KG Weight
Optimum Spray Distance / Max 1.0 / 2.0m		Max Pump Pressure 15Bar / 217PSI
Droplet Size 60-70Microns		Tank Empty 31mins
Flow 140ml/min	Hose Length 1.5m	



Whilst we recommend using TECcare® Control, the Sanitise Pro System is fully compatible with disinfectant solutions based on Quaternary Ammonium Salts or Hypochlorous Acid using appropriate dilution levels. Use of other chemical / disinfectant solutions may invalidate warranty.*

*99.999% effective in inactivating and destroying pathogens when using complete Sanitise Pro System. System comprises NSU370 / RSU150NX Mist Unit applying TECcare® Control Disinfectant Solution.

Please note: Do not spray electrical items such as computers, monitors or electrical sockets at close distances.

- 1 & 2 Precision High-Pressure Misting System
- 3 Stay Cleaning for Longer with 6hrs Runtime



NX300 Pro Cordless Wet Vacuum

CORDLESS, CLEAN, SAFE

Eliminate the risk of slips, trips and falls with no cable, perfect for cleaning up spills in high-traffic areas.

- Quick Spill Clean-Ups
- Emergency Leaks
- Entrance Lobbies
- Washrooms & Toilets



NEW

WBV370NX



- Perfect for High-Traffic Areas
- All-Hours Cleaning
- 1-Hour Fast Charge
- NX300 Pro Cordless Network
- Continuous 40 Minute Runtime
- 480x360x375mm (WxLxH)

9L/15L Capacity Wet/Dry	400W Motor	9.3KG Weight
Power Lithium Battery 36V		
Runtime 40mins	Charge 1hr 80% / 2hrs 100%	
Max Airflow 49L/Sec	Max Pressure 145mBar	
Suction H ₂ O 2200mm	Kit A11/85 (see page 35)	

- 1 ProFlo Wet Floor Tool
- 2 Easy Battery Change
- 3 Battery Level Indicator

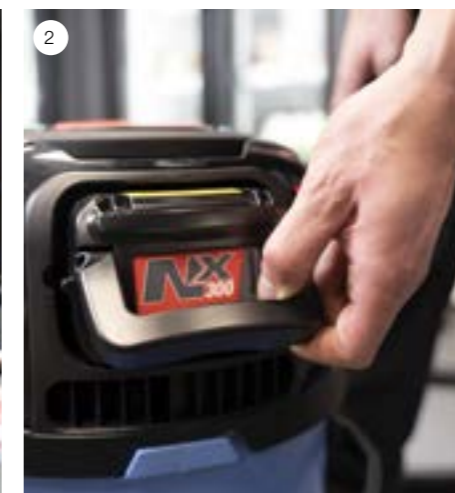
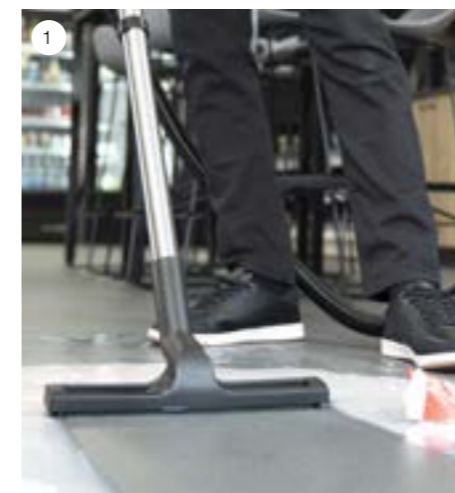



Pro Cordless Network

NX300 Pro Cordless Network delivers professional level performance to a versatile and expanding range. Quicker, safer and more convenient, switching to Pro Cordless increases productivity levels, saving time and money.

Visit: numatic.com/NX300

Smart Safe Charge System

Built-in battery status and health check safety system. The SoH (State of Health) system monitors multiple parameters ensuring battery safety.

Maximum Energy Deployment

Delivering power from cell to machine with minimum power loss via high-quality welded nickel power rails.

Integrated Heatsink Casing

Quickly and efficiently cools the pack in use, optimising delivery of power.

Integrated Cooling Design

Keeping cool allows maximum power delivery, the clever NX300 pack design eliminates air pockets acting as an insulation transmitting heat directly out of the pack.

Integrated Handle

Quickly and easily hot swap batteries across the Pro Cordless Network.

2.0KG Weight | **300Wh** Battery Capacity | **1hr 80% / 2hrs 100%** Charge Time | **Up to 2500** Charge Cycles



Note: Higher ambient temperatures may increase charge time.



Powered by the **NX300 Pro Cordless Network**

CleanCare

NBV190NX



- Newly developed high-performance digital motor
- Part of NX300 Pro Cordless Network
- 80mins runtime and 1 hour fast charge
- 340x340x340mm (WxLxH)

8L Capacity	350W Motor	7.7KG Weight
Power Lithium Battery 36V		
Runtime Hi 50 / Lo 80mins	Charge 1hr 80% / 2hrs 100%	
Suction H ₂ O 1896mm	Kit AS55 (see page 34)	

NBV240NX

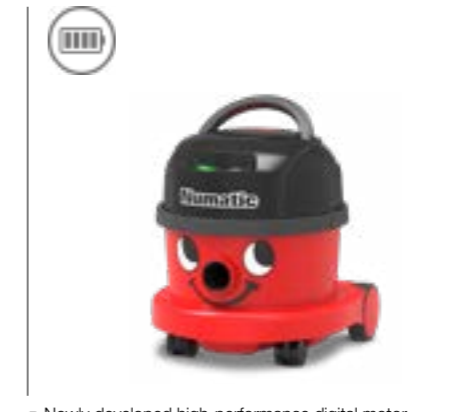

- Newly developed high-performance digital motor
- Part of NX300 Pro Cordless Network
- 80mins runtime and 1 hour fast charge
- Bumper for wall and door protection
- 360x340x415mm (WxLxH)

9L Capacity	350W Motor	8.1KG Weight
Power Lithium Battery 36V		
Runtime Hi 50 / Lo 80mins	Charge 1hr 80% / 2hrs 100%	
Suction H ₂ O 1896mm	Kit AS55 (see page 34)	

PBT230NX



- Newly developed high-performance digital motor
- Part of NX300 Pro Cordless Network
- 80mins runtime and 1 hour fast charge
- Convenient lift-off storage caddy
- Telescopic handle for ease of transit and storage
- 400x450x615mm (WxLxH)

9L Capacity	350W Motor	10.5KG Weight
Power Lithium Battery 36V		
Runtime Hi 50 / Lo 80mins	Charge 1hr 80% / 2hrs 100%	
Suction H ₂ O 1896mm	Kit AS55 (see page 34)	

RSB150NX



RSB150NX HEPA

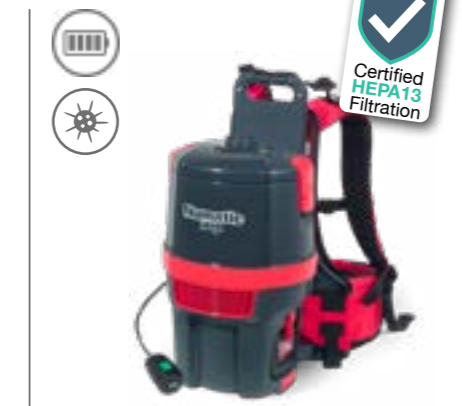

- Newly developed, high-performance digital motor
- Part of NX300 Pro Cordless Network
- 80mins runtime and 1 hour fast charge
- User comfort with ergonomic harness
- Certified HEPA13 filtration down to 0.3 microns at 99.95% efficiency (HEPA Model Only)
- 330x330x570mm (WxLxH)

5L Capacity	350W Motor	8.2/8.6KG Weight 150NX/150NXH
Power Lithium Battery 36V		
Runtime Hi 50 / Lo 80mins	Charge 1hr 80% / 2hrs 100%	
Suction H ₂ O 1896mm	Kit AAT30E (see page 35)	

Why use NX300 Pro Cordless Network?



More Time to Clean



Lower Maintenance



No Cable Trips



Lower Noise



Lower Energy Cost



All Hours Cleaning

Mains Cable Backpacks

Compact, comfortable and convenient, the RSV150 goes wherever you go, making it the perfect cleaning solution for tight and awkward cleaning.



Available as a standard or HEPA model

- 1 Breathable Mesh Panel
- 2 Integrated Hand Control
- 3 Adjustable Cushioned Shoulder Straps

RSV150



RSV150 HEPA



Increase Cleaning Productivity

- Compact, comfortable and convenient design
- Generous 5L capacity
- Extra-long 15.0m cable
- User comfort with ergonomic harness
- Emptying with no dust and no mess
- Certified HEPA13 filtration down to 0.3 microns at 99.95% efficiency (HEPA Model Only)
- 330x330x570mm (WxLxH)

5L Capacity	620W Motor	7.4/7.8KG Weight 150/150H
Power 230V / AC 50/60Hz		
Power Cord 15.0m	Cleaning Range 36.4m	
Suction H ₂ O 2300mm	Kit AAT30E (see page 35)	

Steel Tops

Featuring an all-steel head, the Steel Tops range not only provides exceptional strength, it's also quiet and efficient.

NQS250 / NQS250B

ALL-STEEL



- All-steel construction, tough and hard-wearing
- Blower facility and diffuser attachment (NQS250B)
- Quick and easy cable replacement
- Plugged cable
- 355x355x395mm (WxLxH)

9L Capacity	780W Motor	10.0KG Weight
Power 230V / AC 50/60 Hz		
Power Cord 10.0m	Cleaning Range 26.4m	
Suction H ₂ O 2350mm	Kit AS0 (see page 34)	

NVQ240



- Heavy-duty, all-steel power head
- Quick and easy cable replacement
- Plugged cable
- 360x370x415mm (WxLxH)

9L Capacity	780W Motor	9.65KG Weight
Power 230V / AC 50/60 Hz		
Power Cord 10.0m	Cleaning Range 26.4m	
Suction H ₂ O 2350mm	Kit AS0 (see page 34)	

NVQ370



- Heavy-duty, all-steel power head
- Quick and easy cable replacement
- Plugged cable
- 355x355x485mm (WxLxH)

15L Capacity	780W Motor	10.0KG Weight
Power 230V / AC 50/60 Hz		
Power Cord 10.0m	Cleaning Range 26.4m	
Suction H ₂ O 2350mm	Kit AS0 (see page 34)	

NVQ380



- Heavy-duty, all-steel power head
- Tough Structofoam construction
- Quick and easy cable replacement
- Plugged cable
- 355x355x485mm (WxLxH)

15L Capacity	780W Motor	11.35KG Weight
Power 230V / AC 50/60 Hz		
Power Cord 10.0m	Cleaning Range 26.4m	
Suction H ₂ O 2350mm	Kit AS0 (see page 34)	

MicroLine

PPH320



- Certified HEPA13 filtration down to 0.3 microns at 99.95% efficiency
- Quick and easy cable replacement
- Emptying with no dust and no mess
- Plugged cable rewind
- 355x355x465mm (WxLxH)

12L Capacity	620W Motor	10.0KG Weight
Power 230V / AC 50/60 Hz		
Power Cord 12.5m	Cleaning Range 31.4m	
Suction H ₂ O 2300mm	Kit AS0 (see page 34)	

CRQ370



- Certified HEPA13 filtration down to 0.3 microns at 99.95% efficiency
- Advanced 5-Stage filtration system
- Quick and easy cable replacement
- Conforms to ISO 14644-1 Class 5 classification
- Emptying with no dust and no mess
- 355x355x485mm (WxLxH)

10L Capacity	960W Motor	11.5KG Weight
Power 230V / AC 50/60 Hz		
Power Cord 10.0m	Cleaning Range 26.4m	
Suction H ₂ O 2300mm	Kit A1 (see page 34)	

ADVANCED FILTRATION

High-efficiency 5-stage pre and post-motor HEPA13 filtration conforming to ISO 14644-1 Class 5 cleanroom classification.

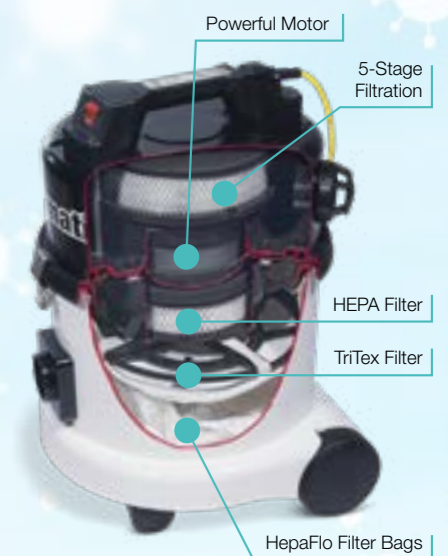

Aircraft Line



The Pro Harness offers enhanced operator comfort, increasing cleaning efficiency, capability and productivity, without any uncomfortable distractions.

RSAV130

Enhanced Harness

- Aircraft specification
- User comfort with ergonomically designed harness
- High-efficiency filtration
- 250x360x440mm (WxLxH)

6L Capacity	960W Motor	7.37KG Weight
Power 110V / AC 400Hz		
Power Cord 18.2m	Cleaning Range 43.2m	
Suction H ₂ O 2400mm	Kit A30A (see page 35)	



Dry Big Capacity Vacuums

Power and performance in industrial terms needs to be matched to long-life, reliability and user satisfaction.

“The NVQs are ideal for numerous trades where they must frequently be moved from one place to another, while still requiring a large and generous working capacity.”

NVQ570/ NVDQ570

- Tough Structofoam construction
- Directional castors for ease of transit
- Quick and easy cable replacement
- 415x415x645mm (WxLxH)

23L Capacity	960W Motor (NVQ)	960Wx2 Motor (NVDQ)
Power 230V / AC 50/60 Hz		
Weight 16.5kg (NVQ)	Weight 18.7kg (NVDQ)	
Power Cord 10.0m	Cleaning Range 26.8m	
Suction H ₂ O 2300mm	Kit BS2 (see page 35)	

NVQ900/ NVDQ900

- Tough Structofoam construction
- Pull handle for ease of transit
- Large rear wheels provide excellent mobility
- Quick and easy cable replacement
- 490x800x880mm (WxLxH)

40L Capacity	960W Motor (NVQ)	960Wx2 Motor (NVDQ)
Power 230V / AC 50/60 Hz		
Weight 25.2kg (NVQ)	Weight 27.7kg (NVDQ)	
Power Cord 10.0m	Cleaning Range 26.8m	
Suction H ₂ O 2300mm	Kit BS2 (see page 35)	



1 Large Rear Wheels for Excellent Mobility
2 High-efficiency ProFlo Dry Floor Tool



1 High-efficiency Hard Floor Tool
2 Easily Remove Bags and Filters

AVQ250

All Steel

- All-steel construction, tough and hard-wearing
- Patented MicroTec noise reduction system
- Aircraft specification
- Plugged cable
- 340x340x395mm (WxLxH)

9L Capacity	960W Motor	10.62KG Weight
Power 110V / AC 400Hz		
Power Cord 18.2m	Cleaning Range 43.2m	
Suction H ₂ O 2500mm	Kit AS4 (see page 34)	

AVQ380

Tough Structofoam

- Heavy-duty, all-steel power head
- Patented MicroTec noise reduction system
- Aircraft specification
- Plugged cable
- 355x355x485mm (WxLxH)

15L Capacity	960W Motor	11.82KG Weight
Power 110V / AC 400Hz		
Power Cord 18.2m	Cleaning Range 43.2m	
Suction H ₂ O 2500mm	Kit AS4 (see page 34)	

STRUCTOFOAM

Cellular structure provides strength and flexibility

- Incredibly tough and long-lasting
- Hard-wearing and chemical-resistant
- Exceptional strength-to-weight ratio
- Lightweight and ergonomic structure

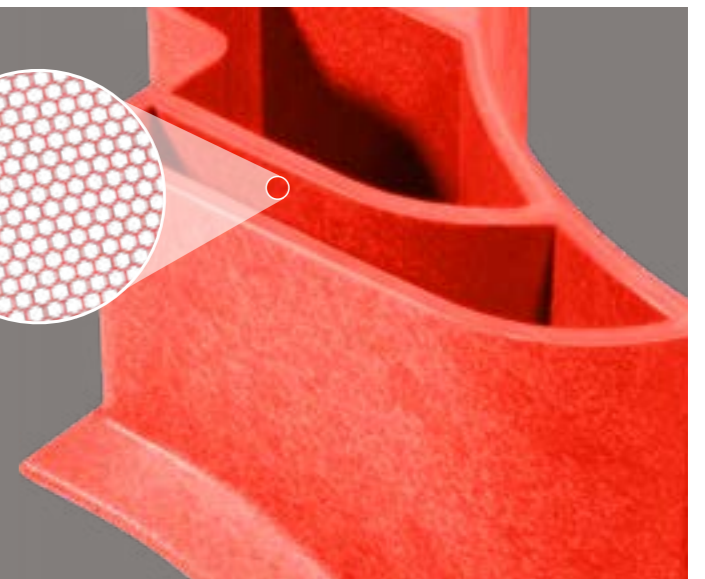
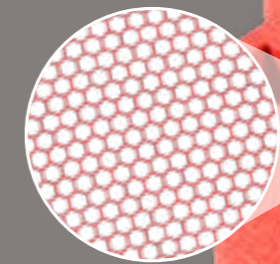

Wet or Dry Vacuums

Professional power and performance in either mode.

- Ready for Wet or Dry
- Built to Last
- Powerful & Professional Performance

WV370



- Wet or dry
- Compact and easy to store
- Lightweight with easy carry handle
- Convenient emptying
- 360x370x510mm (WxLxH)

15L Capacity Dry	9L Capacity Wet	1000W Motor
Power 230V / AC 50/60Hz		Weight 9.0kg
Power Cord 10.0m		Cleaning Range 26.8m
Suction H ₂ O 2400mm		Kit A11 (see page 35)

WV470



Fold Down Transit Handle

- Wet or dry
- Compact and capable
- Convenient folding transit handle
- Large rear wheels for ease of movement
- 360x370x710mm (WxLxH)

27L Capacity Dry	20L Capacity Wet	1000W Motor
Power 230V / AC 50/60Hz		Weight 9.6kg
Power Cord 10.0m		Cleaning Range 26.8m
Suction H ₂ O 2400mm		Kit A11 (see page 35)

WV570 / WVD570



- Wet or dry
- Easy emptying
- Heavy-duty Structofoam construction
- Convenient cable replacement system
- 415x415x645mm (WxLxH)

23L/15L Capacity Dry/Wet	1000W Motor (WV)	1000Wx2 Motor (WVD)
Power 230V / AC 50/60Hz		
Weight 16.3kg (WV)	Weight 18.5kg (WVD)	
Power Cord 10.0m	Cleaning Range 26.8m	
Suction H ₂ O 2400mm	Kit BS8 (see page 35)	

WV900 / WVD900



- Wet or dry
- Easy empty tip handle
- Heavy-duty Structofoam construction
- Convenient cable replacement system
- 490x800x880mm (WxLxH)

40L/32L Capacity Dry/Wet	1000W Motor (WV)	1000Wx2 Motor (WVD)
Power 230V / AC 50/60Hz		
Weight 25.2kg (WV)	Weight 28.0kg (WVD)	
Power Cord 10.0m	Cleaning Range 26.8m	
Suction H ₂ O 2400mm	Kit BS8 (see page 35)	

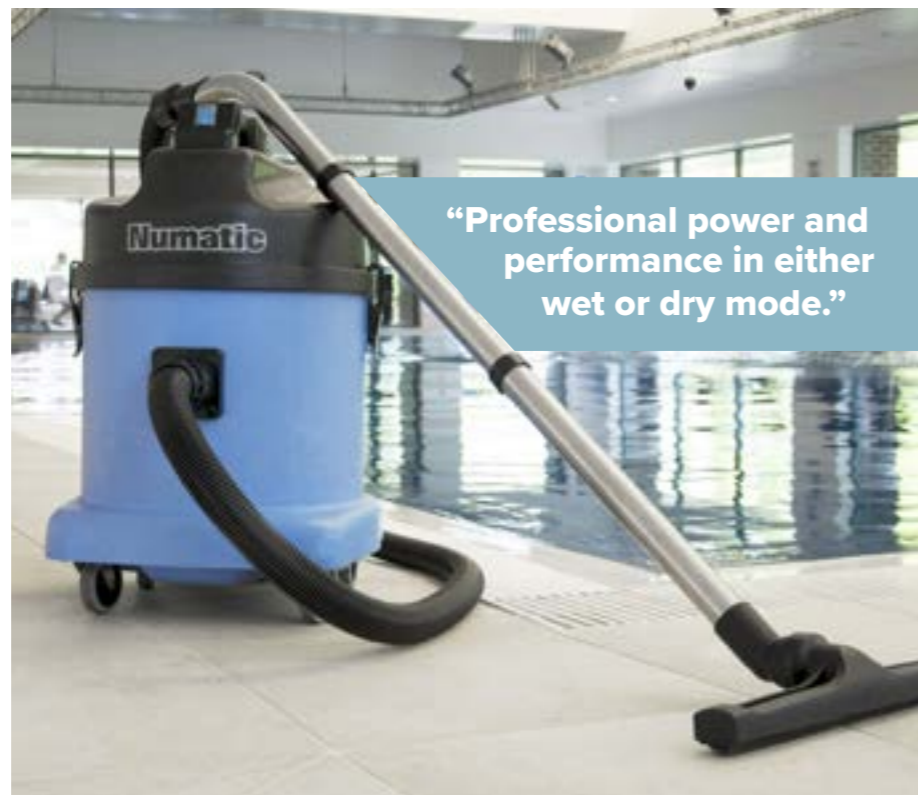

Wet Vacuums

Enhanced with increased efficiency in wet pick-up.

- Unrivalled Performance
- Huge Capacity
- Easy, Clean & Safe Emptying



WV1800DH / WVD1800DH / WVD1800AP



- Wet use only
- Easy emptying with rear dump hose
- Heavy-duty Structofoam construction
- Rear Auto Pump for continuous water extraction (AP model only)
- Convenient cable replacement system
- 684x785x935mm (WxLxH)

70L Capacity	1000W Motor (WV)	1000Wx2 Motor (WVD)
Power 230V / AC 50/60Hz		Weight 31.5kg (WV1800DH)
Weight 34.0kg (WVD1800DH)		Weight 40.4kg (WVD1800AP)
Power Cord 10.0m		Cleaning Range 26.8m
Suction H ₂ O 2400mm		Kit BS7 (see page 35)

WVD2000DH / WVD2000AP



- Wet use only
- Robust steel chassis for ease of transit
- Easy emptying with rear dump hose
- Heavy-duty Structofoam head construction
- Convenient cable replacement system
- Rear Auto Pump for continuous water extraction (AP model only)
- 640x530x970mm (WxLxH)

70L Capacity	1000Wx2 Motor
Power 230V / AC 50/60Hz	
Weight 28.9kg (WVD2000DH)	Weight 36.4kg (WVD2000AP)
Power Cord 10.0m	
Cleaning Range 26.8m	
Suction H ₂ O 2400mm	
Kit BS7 (see page 35)	

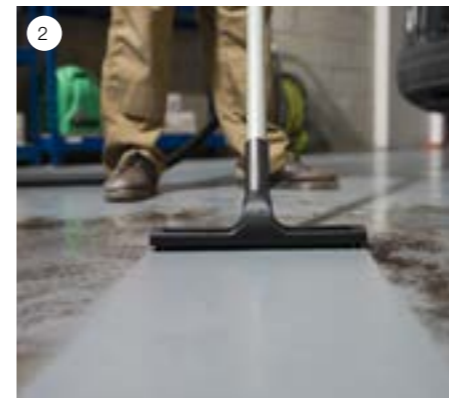

1 Auto Pump for Continuous Water Extraction
2 High-efficiency ProFlo Wet Floor Tool

AUTO EMPTY

Continuous pumping operation precisely where you need it.

Auto Pump (AP) enables for continuous pumping operations and maximum cleaning productivity.



Image for illustration purposes only.

Wet & Dry Vacuums

The unique high-efficiency, dual washable filter system in the CV range enables the user to switch from dry to wet pick-up without the hassle of changing filters or kits.

Effortlessly switch from dry to wet with no hassle.

- Wet & Dry System
- High-efficiency
- A Tool for Every Job

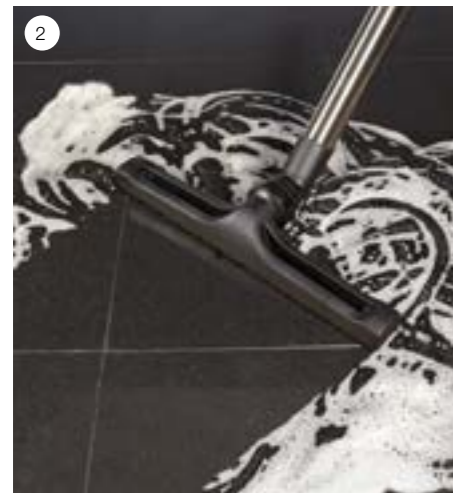

- 1 Dry Floor Tool Pick-up
- 2 Clean, Dry Floors Again and Again
- 3 Colonic Wet and Dry System
- 4 Easy Emptying

CV570 / CVD570



- Wet and dry pick-up
- Washable filter system
- Heavy-duty Structofoam construction
- 415x415x645mm (WxLxH)

13L Capacity	1000W Motor (CV)	1000Wx2 Motor (CVD)
Power 230V / AC 50/60Hz		
Weight 16.3kg (CV)	Weight 18.5kg (CVD)	
Power Cord 10.0m	Cleaning Range 26.8m	
Suction H ₂ O 2400mm	Kit BS8 (see page 35)	

CV900 / CVD900



- Wet and dry pick-up
- Washable filter system
- Heavy-duty Structofoam construction
- Convenient emptying
- 490x800x880mm (WxLxH)

30L Capacity	1000W Motor (CV)	1000Wx2 Motor (CVD)
Power 230V / AC 50/60Hz		
Weight 25.2kg (CV)	Weight 27.7kg (CVD)	
Power Cord 10.0m	Cleaning Range 26.8m	
Suction H ₂ O 2400mm	Kit BS8 (see page 35)	



Tipping Handle for Easy Emptying (900 model only)

Carpet Extraction Vacuums

The compact CleanTecs provide the combination of a PowerFlo liquid pump supply and efficient wet pick-up facility, all incorporated in one unit.

The All-Purpose 4-in-1 carpet and upholstery cleaners.

- Ready for Anything
- Powerful Cleaning Results
- Tank Within a Tank

CT370



- Wet, spray extraction carpet cleaning, upholstery cleaning and car valeting
- Compact and easy to store
- Large rear wheels for ease of transit
- 360x370x510mm (WxLxH)

15L Capacity Dry	9L Capacity Wet	1000W Motor
Power 230V / AC 50/60Hz		Weight 11.23kg
Power Cord 10.0m		Cleaning Range 26.8m
Suction H ₂ O 2400mm		Kit A40A (see page 35)

CT470



- Wet, spray extraction carpet cleaning, upholstery cleaning and car valeting
- Compact and easy to store
- Large rear wheels and folding handle for ease of transit
- 360x370x710mm (WxLxH)

27L Capacity Dry	20L Capacity Wet	1000W Motor
Power 230V / AC 50/60Hz		Weight 14.4kg
Power Cord 10.0m		Cleaning Range 26.8m
Suction H ₂ O 2400mm		Kit A40A (see page 35)



Ergonomic convenient folding handle, large rear wheels and directional castors ease stability during transit.

- 1 Upholstery Extraction Tool
- 2 Fishtail Extraction Tool
- 3 Convenient Carry Handle



Carpet Extraction Vacuums

The CleanTec range provides powerful cleaning results with tough construction, huge capacity and long-life TwinFlo bypass motors so it is easy to store, always on hand and ready for anything.

The All-Purpose 4-in-1 carpet and upholstery cleaners.

- Ready for Anything
- Powerful Cleaning Results
- Tank Within a Tank

CT570 / CTD570



- Wet, spray extraction carpet cleaning, upholstery cleaning and car valeting
- Heavy-duty Structofoam construction
- Convenient cable replacement system
- 415x415x645mm (WxLxH)

23L/15L Capacity Dry/Wet	1000W Motor (CT)	1000Wx2 Motor (CTD)
Power 230V / AC 50/60Hz		
Weight 18.98kg (CT)	Weight 20.0kg (CTD)	
Power Cord 10.0m	Cleaning Range 26.8m	
Suction H ₂ O 2400mm	Kit A41A (see page 35)	

CT900 / CTD900



- Wet, spray extraction carpet cleaning, upholstery cleaning and car valeting
- Easy emptying with tip handle
- Heavy-duty Structofoam construction
- 490x800x880mm (WxLxH)

40L/32L Capacity Dry/Wet	1000W Motor (CT)	1000Wx2 Motor (CTD)
Power 230V / AC 50/60Hz		
Weight 25.28kg (CT)	Weight 27.78kg (CTD)	
Power Cord 10.0m	Cleaning Range 26.8m	
Suction H ₂ O 2400mm	Kit A41A (see page 35)	

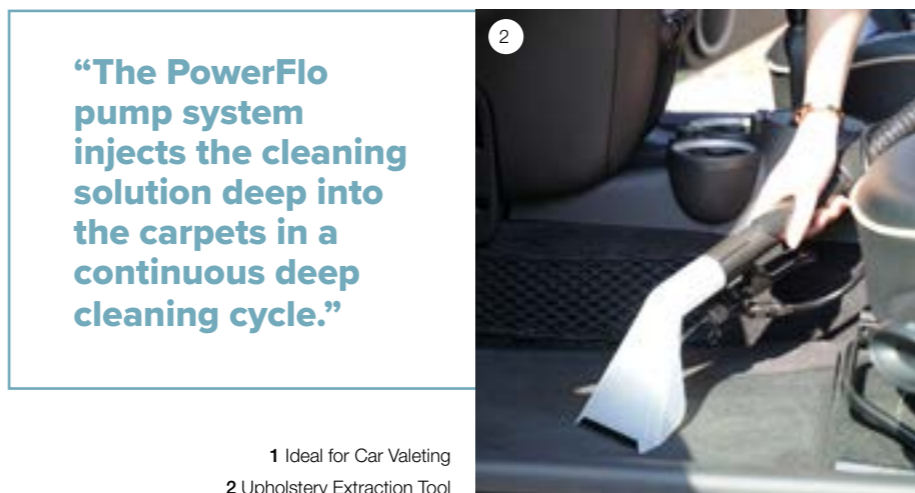

“The PowerFlo pump system injects the cleaning solution deep into the carpets in a continuous deep cleaning cycle.”

1 Ideal for Car Valeting
2 Upholstery Extraction Tool

TRIJET CARPET CLEANING

- Uniform fluid distribution
- Easy pull-back movement
- Heavy-duty, Aluminium construction

NHL15



- Carpet cleaning and upholstery / spot cleaning tools
- Uniform fluid distribution with TriJet carpet extraction
- Hi-Lo system for pressure when you need it
- 435x425x725mm (WxLxH)

15L Capacity	1000W Motor	35.0KG Weight
Power 230V / AC 50/60Hz		
Power Cord 10.0m	Cleaning Range 26.8m	
Suction H ₂ O 2400mm	Kit BS27 (see page 35)	

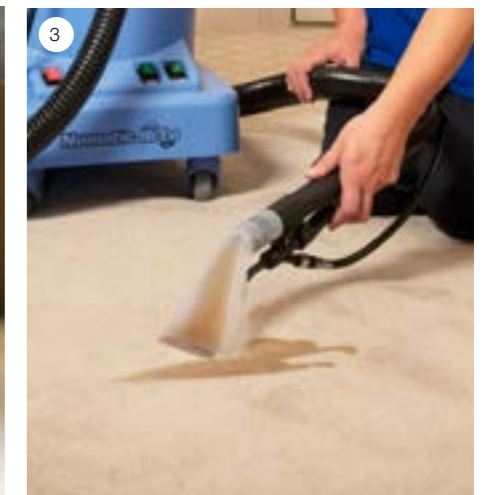

1 & 2 High-performance, TriJet Carpet Extraction Tool
3 Upholstery and Spot Cleaning Extraction Tool

CleanCare Kits

Dry Kits

KIT AS0 - 903146



601008	Stainless Steel Extension Tube (x2)
601052	Stainless Steel Tube Bend with NPC Volume Control
915909	2.2m FloMax Conical Hose
912358	280mm ProFlo Combination Floor Tool
601141	Double Taper Hose / Tool Adaptor
601142	240mm Crevice Tool
601144	65mm Dusting Tool
601145	150mm Upholstery Tool
601146	150mm Slide-on Brush for Upholstery Tool

KIT NS1 - 607365



601008	Stainless Steel Extension Tube (x2)
601027	Stainless Steel Bend with (Black) Volume Control
601107	1.9m NuFlex Threaded Hose
902070	300mm Combination Floor Tool
601142	240mm Crevice Tool
601144	65mm Soft Dusting Brush

KIT A1 - 607301



601008	Stainless Steel Extension Tube (x2)
601052	Stainless Steel Tube Bend with NPC Volume Control
915907	2.2m Parallel Hose
902071	300mm Combination Floor Tool
601141	Double Taper Hose / Tool Adaptor
601142	240mm Crevice Tool
601144	65mm Soft Dusting Brush
601145	150mm Upholstery Tool
601146	150mm Slide-on Brush for Upholstery Tool

NUMATIC QUICK BOXED ACCESSORIES

915242	UK Plug and Cable
915243	EURO Plug and Cable
915170	Quick Battery
915351	Wall Mount
915353	Extension Handle
914744	Floor Tool
915352	Crevice & Combi Tool Pack
915358	Brush Bar
915527	Mini Motorised Tool
915356	Wand
915632	Handheld Unit
914592	Quick Pods (Pack of 10 UK)
914593	Vanilla Scent Pods (Pack of 10)
915350	Passion Fruit Scent Pods (Pack of 10)
915674	Rose Scent Pods (Pack of 10)
915357	Scent Pod Cap



AS73



601008	Stainless Steel Extension Tube (x2)
601052	Stainless Steel Tube Bend with NPC Volume Control
914761	1.9m Parallel Hose
912358	280mm ProFlo Combination Floor Tool
601142	240mm Crevice Tool
601144	65mm Soft Dusting Brush

NX300

NX300 ACCESSORIES

913686	NX300 Battery
911334	NX300 Charging Dock
910820	NX300 Dual Charging Dock
NX300 Mains Cable for Charging Docks	
912365	UK
912361	EURO
912364	SWISS
912360	AUS/NZ
912362	USA
912363	S.AFRICA
913041	JPN
NX300 Dual Charging Dock with Mains Cable	
915748	UK
915749	EURO
915750	SWISS
915751	AUS/NZ
915752	USA
915753	S.AFRICA
915754	JPN



Specialised Kits

KIT AS55 - 916028



914413	2.0m Parallel Hose
601008	Stainless Steel Extension Tube (x2)
601052	Stainless Steel Tube Bend with NPC Volume Control
912358	280mm ProFlo Combination Floor Tool
601141	Double Taper Hose / Tool Adaptor
601142	240mm Crevice Tool
601144	65mm Soft Dusting Brush
601145	150mm Upholstery Tool
601146	150mm Slide-on Brush for Upholstery Tool

KIT AS4 - 900961



601008	Stainless Steel Extension Tube (x2)
601052	Stainless Steel Tube Bend with NPC Volume Control
914411	2.2m FloMax Conical Hose
601430	290mm FreeFlo Floor Tool
601141	Double Taper Hose / Tool Adaptor
601142	240mm Crevice Tool
601144	65mm Dusting Tool
601145	150mm Upholstery Tool
601146	150mm Slide-on Brush for Upholstery Tool

Specialised Kits

KIT A30A - 607817



914979	1.2m NuFlex RSBV Threaded Hose
601008	Stainless Steel Extension Tube (x2)
601052	Stainless Steel Tube Bend with NPC Volume Control
902071	300mm Combination Floor Tool
601141	Double Taper Hose / Tool Adaptor
601144	65mm Soft Dusting Brush

KIT AAT30E - 915883



915195	1.2m RSB / RSV150 Hose
915195	Aluminium Tube Bend with NPC Volume Control
914759	Aluminium Telescopic Wand
902923	270mm ProFlo Combination Floor Tool
601141	Double Taper Hose / Tool Adaptor
601144	65mm Soft Dusting Brush

KIT BS2 - 916230



602102	2.4m NuFlex Threaded Hose
602931	Aluminium Tube Bend
602920	Aluminium Extension Tube (x2)
602384	400mm ProFlo Brush / Rubber Floor Tool
601144	65mm Soft Dusting Brush
602159	38/32mm Adaptor
602160	305mm ABS Crevice Tool

Wet Kits

KIT A11/85 - 607311



915907	2.2m Parallel Hose
601027	Stainless Steel Bend with (Black) Volume Control
601008	Stainless Steel Extension Tube (x2)
900954	300mm MultiFlo Wet Pick-up Tool
900918	300mm MultiFlo Dry Brush Tool

KIT BS7 - 607249



602102	2.4m NuFlex Threaded Hose
602919	Stainless Steel Tube Bend
602920	Stainless Steel Extension Tube (x2)
602380	400mm ProFlo Wet Pick-up Floor Tool

KIT BS8 - 607241



602102	2.4m NuFlex Threaded Hose
602919	Stainless Steel Tube Bend
602920	Stainless Steel Extension Tube (x2)
602380	400mm ProFlo Wet Pick-up Floor Tool
602381	400mm ProFlo Dry Pick-up Floor Tool

Extraction Kits

KIT A40A - 607147



601399	4.0m CleanTec Extraction Hose
601009	Stainless Steel Extraction Trigger Bend Tube
601006	Stainless Steel Lower Tool Extraction Tube
601008	Stainless Steel Extension Tube
601126	275mm Fishtail Extraction Tool
601225	100mm Upholstery Extraction Tool
601968	CleanTec Trigger Valve and Spray Tube

KIT A41A - 607148



601399	4.0m CleanTec Extraction Hose
601009	Stainless Steel Extraction Trigger Bend Tube
601006	Stainless Steel Lower Tool Extraction Tube
601008	Stainless Steel Extension Tube
601423	275mm Aluminium Extraction Tool
601225	100mm Upholstery Extraction Tool
601968	CleanTec Trigger Valve and Spray Tube

KIT BS27 - 607248



602399	4.0m CleanTec Extraction Hose
602922	Stainless Steel Extraction Tube Bend
602920	Stainless Steel Extension Tube (x2)
602937	145mm Stainless Steel Extension Tube
602200	CleanTec TriJet Extraction Floor Tool
602300	CleanTec TriJet Trigger and Solution Tube
602225	100mm Upholstery Extraction Tool

ProCare

Advanced, professional cleaning for the collection and control of dust and hazardous substances.

ProCare Contents

NuTec Industrial	38
Anti-Static	38
Dustcare	38
M-Class	39
TradeLine	39
H-Class	40-41
ProCare Kits	42

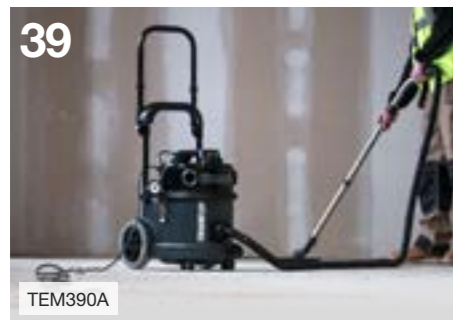

TRADELINE
390



Compact, tough and highly mobile, the TradeLine vacuum combines a specialist on-tool extractor with a big clean-up machine.

See page 39 for details.



NuTec Industrial

NTD750



- TwinFlo 2-motor Structofoam power head
- Industrial vacuum suitable for many applications including; boiler cleaning, floor cleaning, metalworking, dirt, dust or debris, and more
- 510x510x960mm (WxLxH)

35L Capacity	1000Wx2 Motor	20.8KG Weight
Power 230V / AC 50/60Hz		
Power Cord 10.0m	Cleaning Range 26.8m	
Suction H ₂ O 2400mm	Kit BS5 (see page 42)	

NTD2003



- Big capacity machine with TwinFlo 2-motor Structofoam power head
- Stainless Steel container with heavy-duty chassis
- 560x660x1145mm (WxLxH)

60L Capacity	1000Wx2 Motor	33.0KG Weight
Power 230V / AC 50/60Hz		
Power Cord 10.0m	Cleaning Range 26.8m	
Suction H ₂ O 2400mm	Kit BS5 (see page 42)	

NTT2003



- Triplex power head in all-steel construction
- Mounted on an all-steel heavy-duty chassis, easily demounted for emptying
- 560x660x1075mm (WxLxH)

60L Capacity	1000Wx3 Motor	36.0KG Weight
Power 230V / AC 50/60Hz		
Power Cord 10.0m	Cleaning Range 26.8m	
Suction H ₂ O 2400mm	Kit BS5 (see page 42)	

M-Class

**MES570
MES570A
MED570
MED570A**



Power Outlet Socket (Optional)



- M-Class Compliant – IEC/EN 60335-2-69
- High-efficiency internal AirFlo system with Low flo and bag full indicator
- TriTex filtration and HepaFlo filter bag
- Plugged easy cable replacement system
- Optional Auto Operation Power Outlet Socket
- 415x415x780mm (WxLxH)

23L Capacity	620W Motor (MES)	620Wx2 Motor (MED)
Power Outlet Socket Optional (MES570A/MED570A)	Weight 19.2/20.8kg (MES/MED)	
Power 230V / AC 50/60Hz	Weight 19.3/20.9kg (MES(A)/MED(A))	
Power Cord 10.0m	Cleaning Range 30.0m	
Suction H ₂ O 2300mm	Kit BS5 (see page 42)	

**MES900
MES900A
MED900
MED900A**



- M-Class Compliant – IEC/EN 60335-2-69
- High-efficiency internal AirFlo system with Low flo and bag full indicator
- TriTex filtration and HepaFlo filter bag
- Plugged easy cable replacement system
- Optional Auto Operation Power Outlet Socket
- 490x800x945mm (WxLxH)

40L Capacity	620W Motor (MES)	620Wx2 Motor (MED)
Power Outlet Socket Optional (MES900A/MED900A)	Weight 25.1/27.6kg (MES/MED)	
Power 230V / AC 50/60Hz	Weight 25.2/27.7kg (MES(A)/MED(A))	
Power Cord 10.0m	Cleaning Range 30.0m	
Suction H ₂ O 2300mm	Kit BS5 (see page 42)	

L-CLASS M-CLASS H-CLASS

What type of vacuum extractor do you need?



General dust, mixed dust, gypsum



Soft / hardwood, silica, masonry, paint, plastic, ceramic



Asbestos

For guidance only. Find out more at www.hse.gov.uk/construction

Anti-Static Dustcare

HAS750



- H13 (EN1822)
- Full anti-static specification in machine and accessories
- The non-conductive specification continually discharges the static build up during use
- 510x510x960mm (WxLxH)

35L Capacity	960W Motor	23.0KG Weight
Power 230V / AC 50/60Hz		
Power Cord 8.5m	Cleaning Range 25.6m	
Suction H ₂ O 2500mm	Kit HAS (see page 42)	

NES570/A / NED570/A



- Optional Auto Operation Power Outlet Socket
- Low flow and bag full indicator
- High-efficiency internal AirFlo system
- 415x415x645mm (WxLxH)

23L Capacity	620W Motor (NES)	620Wx2 Motor (NED)
Power Outlet Socket Optional (NES570A/NED570A)		
Power 230V / AC 50/60Hz	Weight 18/20kg (NES/NED)	
Power Cord 10.0m	Cleaning Range 26.8m	
Suction H ₂ O 2300mm	Kit BS5 (see page 42)	

NES900/A / NED900/A



Power Outlet Socket (Optional)

- Optional Auto Operation Power Outlet Socket
- Low flow and bag full indicator
- High-efficiency internal AirFlo system
- 490x800x880mm (WxLxH)

40L Capacity	620W Motor (NES)	620Wx2 Motor (NED)
Power Outlet Socket Optional (NES900A/NED900A)		
Power 230V / AC 50/60Hz	Weight 27/29kg (NES/NED)	
Power Cord 10.0m	Cleaning Range 26.8m	
Suction H ₂ O 2300mm	Kit BS5 (see page 42)	

TradeLine

Compact, tough and highly mobile, the TradeLine vacuum combines a specialist on tool extractor with a big clean-up machine to cover almost any application.

TEL390S



- L-Class Compliant - IEC/EN 60335-2-69
- Huge cleaning reach, with 10m cable and 2.9m hose
- Large rear wheels for ease of transit
- Tough, durable and built to last
- 400x450x600mm (WxLxH)

18L Capacity	620W Motor	10.8KG Weight
Power 230V / AC 50/60Hz		
Power Cord 10.0m	Cleaning Range 28.0m	
Suction H ₂ O 2300mm	Kit AS10 (see page 42)	

TEM390A



Extending Pull Handle

- M-Class Compliant - IEC/EN 60335-2-69
- Huge cleaning reach, with 10m cable and 2.9m hose
- Large rear wheels and extending pull handle for ease of transit
- 2200W Automatic power take-off
- 400x450x1010mm (WxLxH)

18L Capacity	620W Motor	14.3KG Weight
Power 230V / AC 50/60Hz		
Power Cord 10.0m	Cleaning Range 28.0m	
Suction H ₂ O 2300mm	Kit AS10 (see page 42)	



1 Specialist FreeFlo Tool for Hard Floors

2 Long 10m Cable

H-Class

H-Class equipment is the legal requirement when working with high-risk, non-explosive, hazardous dusts and materials, including asbestos.



HZ370



- H-Class Compliant - IEC/EN 60335-2-69
- TriTex filtration and HepaFlo filter bags
- Compact and ready to go
- Powerful, long-life 960W motor
- 355x355x570mm (WxLxH)

15L Capacity	960W Motor	11.0KG Weight
Power 230V / AC 50/60Hz		
Power Cord 10.0m	Cleaning Range 26.0m	
Suction H ₂ O 2500mm	Kit AA18 (see page 42)	

HZ390S / L



Extending Pull Handle (HZ390L)

- H-Class Compliant - IEC/EN 60335-2-69
- TriTex filtration and HepaFlo filter bags
- Compact and ready to go
- Large rear wheels and pull handle
- HZ390S 400x450x600mm (WxLxH)
- HZ390L 400x450x1010mm (WxLxH)

18L Capacity	960W Motor	11.2KG Weight (S)	12.6KG Weight (L)
Power 230V / AC 50/60Hz			
Power Cord 10.0m	Cleaning Range 26.0m		
Suction H ₂ O 2500mm	Kit AA18 (see page 42)		



- 1 Easy, Clean and Safe Emptying
- 2 All-terrain Large Rear Wheels
- 3 Stainless Steel Gulper / Scraper Tool
- 4 Transit Safety Cap

HZ570 / HZD570



- H-Class Compliant - IEC/EN 60335-2-69
- All-steel head construction
- Plugged easy cable replacement system
- 415x415x746mm (WxLxH)

23L Capacity	960W Motor (HZ)	960Wx2 Motor (HZD)
Power 230V / AC 50/60Hz		Weight 18/20kg (HZ/HZD)
Power Cord 10.0m	Suction H ₂ O 2500mm	
Cleaning Range (HZ) 26.0m	Cleaning Range (HZD) 26.8m	
Kit AA19 (HZ) (see page 44)	Kit BB19 (HZD) (see page 42)	

HZ900 / HZD900



- H-Class Compliant - IEC/EN 60335-2-69
- All-steel head construction
- Plugged easy cable replacement system
- 490x800x880mm (WxLxH)

40L Capacity	960W Motor (HZ)	960Wx2 Motor (HZD)
Power 230V / AC 50/60Hz		Weight 28/30kg (HZ/HZD)
Power Cord 10.0m	Suction H ₂ O 2500mm	
Cleaning Range (HZ) 26.0m	Cleaning Range (HZD) 26.8m	
Kit AA20 (HZ) (see page 44)	Kit BB20 (HZD) (see page 42)	

HZC CARTRIDGE

All dust is safely contained within a sealed, HEPA13 filter cartridge, so you can breathe easy.

Watch the full video at: numatic.co.uk



Designed, engineered and built with the tradesman in mind, the HZC390 offers a safe and convenient solution for those whose work brings them into infrequent contact with hazardous dusts and materials.



- 1 All-Steel Head**
Heavy-duty power head.
- 2 HZC Disposable Cartridge**
HEPA H13 Filter conforms to EN1822. Fits all HZC machines.
- 3 Robust Drum**
Tough drum construction with all-terrain large rear wheels for stairs and uneven surfaces.

HZC390S / HZC390L

- H-Class Compliant - IEC/EN 60335-2-69
- Disposable filter cartridge
- Quick, simple and safe emptying
- Compact and ready to go
- HZ390S 400x450x600mm (WxLxH)
- HZ390L 400x450x1010mm (WxLxH)

13L Capacity	1000W Motor	12.2KG Weight (S)	13.0KG Weight (L)
Power 230V / AC 50/60Hz			
Power Cord 10.0m	Cleaning Range 26.0m		
Suction H ₂ O 2500mm	Kit AA16 (see page 42)		



Extending Pull Handle (HZC390L)

HZC DISPOSABLE CARTRIDGE



- HEPA H13 Filter - Conforms to EN1822
- Fits all HZC machines
- 345x321x283mm (WxLxH)

13L Capacity	1.75KG Weight
------------------------	-------------------------

ProCare Kits

KIT AS10 - 908283



601052	Stainless Steel Extension Tube (x2)
601008	Stainless Steel Tube Bend with NPC Volume Control
914762	2.8m NuFlex Threaded Hose
900918	300mm MultiFlo Dry Brush Tool
601430	290mm FreeFlo Floor Tool
601141	Double Taper Hose / Tool Adaptor
601142	240mm Crevice Tool
601144	65mm Soft Dusting Brush
601145	150mm Upholstery Tool
601146	150mm Slide-on Brush for Upholstery Tool
601176	Multi Size Power Tool Adaptor

KIT AA16 - 909539



915907	2.2m Parallel Hose
601142	240mm Crevice Tool
602161	152mm Rubber Brush with Soft Bristles
602159	38 / 32mm Adaptor
601144	65mm Soft Dusting Brush
601141	Double Taper Hose / Tool Adaptor
601917	280mm Stainless Steel Gulper / Scraper Tool (32mm)

KIT AA18 - 902756



915907	2.2m Parallel Hose
601142	240mm Crevice Tool
602161	152mm Rubber Brush with Soft Bristles
602159	38 / 32mm Adaptor
601144	65mm Soft Dusting Brush
601141	Double Taper Hose / Tool Adaptor
601917	280mm Stainless Steel Gulper / Scraper Tool (32mm)
908229	Roll of 10 x 120L Waste Bags (700 x 1100mm), Grey

KIT AA19 - 902757 / AA20 - 902758



915907	2.2m Parallel Hose (AA19 HZ570)
601101	2.4m NuFlex Threaded Hose (AA20 HZ900)
604017	10 x (NVM-3BH) HepaFlo Dust Bags (AA19 HZ570)
604019	10 x (NVM-4BH) HepaFlo Dust Bags (AA20 HZ900)
601142	240mm Crevice Tool
602161	152mm Rubber Brush with Soft Bristles
602159	38 / 32mm Adaptor
601144	65mm Soft Dusting Brush
908229	Roll of 10 x 120L Waste Bags (700 x 1100mm), Grey
601141	Double Taper Hose / Tool Adaptor
601917	280mm Stainless Steel Gulper / Scraper Tool (32mm)
604116	Primary PermaTex Filter for 356mm Machine

KIT BB19 - 607349 / BB20 - 607350



602102	2.4m NuFlex Threaded Hose
604017	10 x (NVM-3BH) HepaFlo Dust Bags (BB19 HZD570)
604019	10 x (NVM-4BH) HepaFlo Dust Bags (BB20 HZD900)
602161	152mm Rubber Brush with Soft Bristles
604144	65mm Soft Dusting Brush
908229	Roll of 10 x 120L Waste Bags (700mm x 1100mm)
602160	305mm ABS Crevice Tool
602923	280mm Stainless Steel Gulper / Scraper Tool (38mm)
602159	38 / 32mm Adaptor

KIT BS5 - 607335

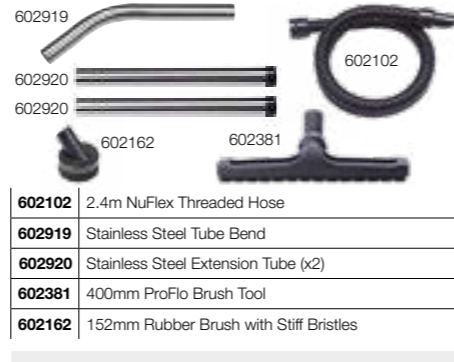

602102	2.4m NuFlex Threaded Hose
602919	Stainless Steel Tube Bend
602920	Stainless Steel Extension Tube (x2)
602381	400mm ProFlo Brush Tool
602162	152mm Rubber Brush with Stiff Bristles

KIT HAS - 607661



602111	2.6m ATX Hose
602112	ATX 400mm Widetrack Brush Tool
602919	Stainless Steel Tube Bend
602929	ATX Stainless Steel Extension Tube (x2)
909185	Conductive Dusting Brush
602125	ATX 130mm Conductive Rubber Gulper Tool
604019	10 x (NVB-4BH) HepaFlo Dust Bags
602923	280mm Stainless Steel Gulper / Scraper Tool
908229	Roll of 10 x 120L Waste Bags (700 x 1100mm), Grey



TRADELINE
390

Compact, tough and highly mobile, the TradeLine vacuum combines a specialist on-tool extractor with a big clean-up machine.

✓ TradeLine On-tool Extraction

✗ No On-tool Extraction

TradeLine on-tool extraction in use. (See page 39 for product information)

FloorCare

Providing innovative, reliable and effective floorcare solutions, even in the most demanding environments.

FloorCare Contents

Hurricane / NuSpeed Range	46-47
TwinTec Mains Range	48
Nu-Assist	49
NX300 FloorCare Range	50-53
NX1K Lithium Range	54-57
Brushes & Pad Drives	58-59
FloorCare Accessories	60-61



A New Generation of Cleaning Power

NX1K brings the latest Lithium technology to the Numatic FloorCare Range, delivering more runtime with faster, flexible charging and long-life power with the same professional results and reliability.

See pages 54-57 for details.



WHICH MACHINE IS BEST FOR YOU?



Hurricane Range

HFM1515G

- Scrubbing

HFM1523G

- General Purpose

HFM1530G

- Polishing

HFM1545G

- Polishing

- Fully adjustable handle
- Optional solution tank
- Optional 10kg weight
- 460x560x1250mm (WxLxH)

450MM Deck Size	1500W Motor	32.0KG Weight
Power 230V / AC 50/60Hz - 1515G / 1523G / 1530G		
Power 230V / AC 50Hz - 1545G		
Vacuum Dry - Optional	Cleaning Range 32.0m	
Brush Size 450mm	Pad Size 400mm	
Brush Speed RPM		
1515G - 150	1523G - 230	1530G - 300 1545G - 450

HNS1550G

- Burnishing

- Fully adjustable handle
- High-speed burnisher
- Simple load adjustment
- 560x740x1260mm (WxLxH)

500MM Deck Size	1500W Motor	35.0KG Weight
Power 230V / AC 50Hz		
Cleaning Range 32.0m		
Pad Size 500mm		Pad Pressure - Variable
Vacuum Dry - Optional		Brush Speed 1500rpm

NuSpeed Range

NLL332

- Lightweight
- General Purpose

Easy Storage
Folds flat for compact convenience.

Wide Range of Accessories
A variety of brushes and pads are available to suit your cleaning needs.

Solution Tank (Optional)

- Optional solution tank
- Folds flat for easy storage
- Full range of brushes and pads
- 330x540x1145mm (WxLxH)

330MM Deck Size	400W Motor	18.0KG Weight
Power 230V / AC 50Hz		
Cleaning Range 32.0m		
Tank Capacity 4.0L	Brush Speed 200rpm	
Brush Size 330mm	Pad Size 330mm	

Images may include optional accessories for illustration purposes.

Lightweight

A light commercial or domestic machine. Suited to the non-professional cleaner. Perfect for a variety of flooring options, including vinyl, slate, limestone and quarry tiles.

Scrubbing

Professional use machines for a range of deep-cleaning situations in leisure, industry and floor maintenance.

General Purpose

Medium speed machines for a variety of uses and floor types. Lighter scrubbing and polishing on vinyl, stone and wood.

Polishing

Professional higher speed machines for spray cleaning and polishing a variety of floors including vinyl and wood.

Burnishing

Professional, ultra-high speed machines for burnishing vinyl floors treated with metallised emulsion polishes - for the wet-look shine with specialised UH speed floor pads.

Heavy-Duty Scrubbing

Specialist scrubbing machine with extra weight for heavy-duty situations.

Please note information provided is for guidance only, please consult manufacturers guidance before use. *Refer to manufacturer/supplier's data sheet for advice as not all wood/laminates are waterproof.

TwinTec Mains Range

The TwinTec 1840 Mains Cable machine has been designed to address the question of size, whilst being exceptionally compact, with a performance equal to bigger machines.

TT1840G

- Performance of a bigger machine
- Clean, dry and safe floors
- Easy brush or pad change
- User-friendly controls
- Fully adjustable handle
- 520x880x1132mm (WxLxH)

18L Tank Capacity	400W Brush Motor	38.5KG Weight
Power 230V / AC 50Hz		
Deck Size 400mm	Cleaning Range 42.0m	
Brush Size 400mm	Pad Size 360mm	
Vac Motor 300W	Brush Speed 150rpm	



Sustainable Cleaning

Our Centrifugal Water System ensures precise distribution across the brush or pad, delivering on cleaning performance whilst saving water.



The TwinTec Mains Cable range has masterful performance moving under its own brush power with amazing speed and purpose. Available with 450mm or 550mm scrub width.



TT4045G



- Simple controls
- Fully adjustable handle
- Tilting deck for easy brush / pad change
- 470x890x1100mm (WxLxH)

40L Tank Capacity	1500W Brush Motor	67.0KG Weight
Power 230V / AC 50Hz		
Deck Size 450mm	Cleaning Range 42.0m	
Brush Size 450mm	Pad Size 400mm	
Vac Motor 1200W	Brush Speed 150rpm	

TT4055G



- Simple controls
- Fully adjustable handle
- Tilting deck for easy brush / pad change
- 560x935x1100mm (WxLxH)

40L Tank Capacity	1500W Brush Motor	68.0KG Weight
Power 230V / AC 50Hz		
Deck Size 550mm	Cleaning Range 42.0m	
Brush Size 550mm	Pad Size 500mm	
Vac Motor 1200W	Brush Speed 150rpm	

- 1 Fully Adjustable Handle
- 2 Tilting Deck for Easy Brush Change and Storage
- 3 Easy to Use Controls

Nu-Assist

Training & Support Around the Clock

The Nu-Assist App offers the benefit of online training through a simple, versatile and user-friendly solution, resulting in increased cleaning performance and productivity.

- 24/7 Access to Multilingual Training
- On hand Troubleshooting and Maintenance
- Increased Cleaning Productivity
- Product Training

How it works

1. Scan the QR Code on Machine
2. Open in App or Mobile Browser
3. View Quick Start Videos
4. Carry Out Maintenance Checklist
5. Complete Operation Training



Scan me to download Nu-Assist App

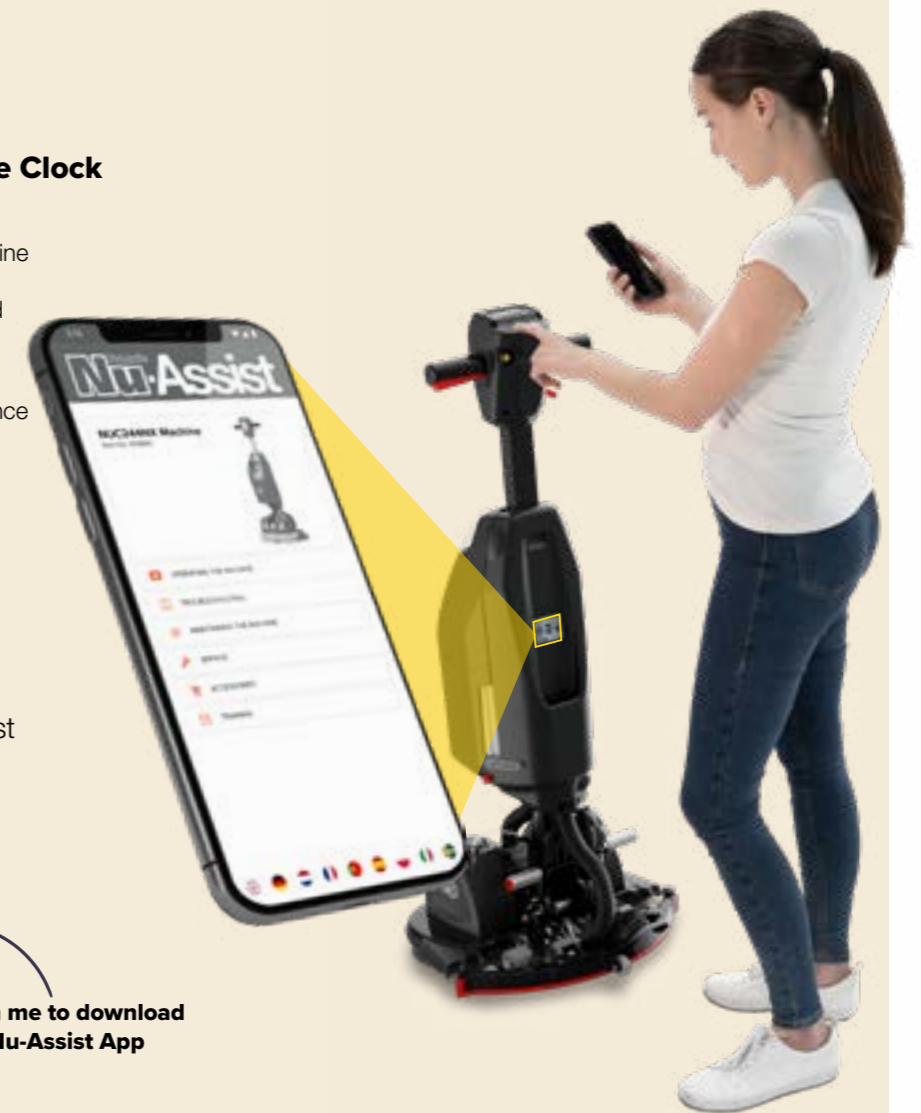

GENUINE
Numatic
PART

For Genuine Numatic
Brushes, Pads and
Accessories
See pages 58-61



PRO CORDLESS NETWORK INCREASES PRODUCTIVITY

NX300 Pro Cordless Network delivers professional level performance to a versatile and expanding range. Quicker, safer and more convenient, switching to Pro Cordless raises productivity levels, saving time and money.



More Time to Clean



Lower Maintenance



No Cable Trips



Lower Noise



Lower Energy Cost



All Hours Cleaning

* Higher ambient temperatures may increase charge time.

NX300 FloorCare Range

Power the Entire Fleet with NX300 Pro Cordless Network.

The NX300 Pro Cordless Network provides the opportunity of continuous cleaning through hot-swapping batteries across a versatile and expanding range.

- Enhanced Energy Storage
- One Fits All Productivity
- Cost Effective
- 1-Hour Fast Charge
- NX300 Pro Cordless Network

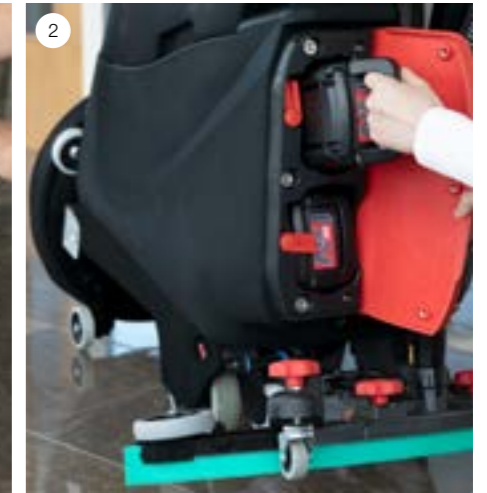
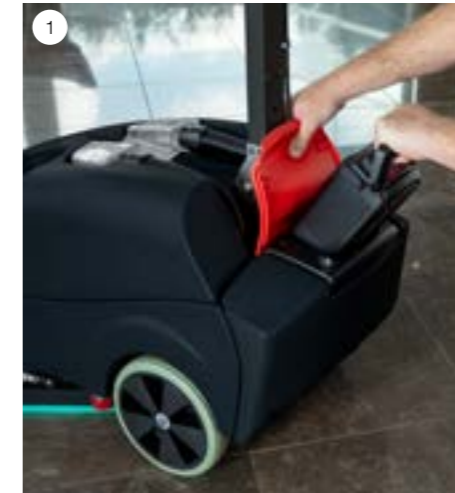

1 TTB1840NX Battery Replacement
2 TTB3045NX Battery Replacement

NEW 244NX-R

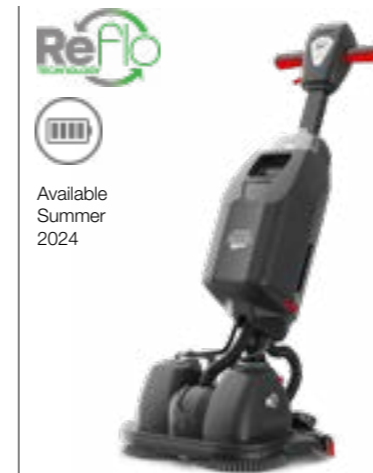

- 80mins runtime
- 1 hour fast charge
- One-pass performance
- Centrifugal water delivery
- Sustainably engineered from a minimum 20% recycled plastic, including accessories
- Part of NX300 Pro Cordless Network
- 520x450x1180mm (WxLxH)

2.2L Tank Capacity	3L Recovery Tank	100W Vac Motor	140RPM Brush Speed
Power 36V		Brush Motor 2x200W	
Recharge Time 1hr 80% / 2hrs 100%			
Deck Size 440mm		Runtime Up to 80mins	
Brush/Pad Size 2x220mm		Net Weight 21.3kg	

NEW TTB1840NX-R

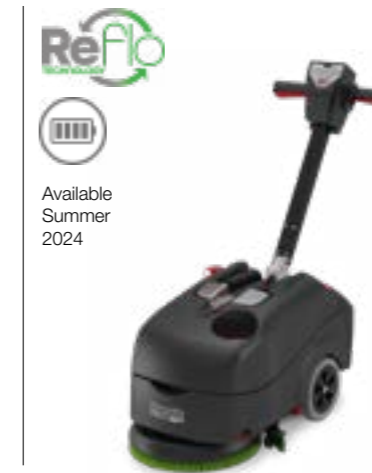

- 60mins runtime
- 1 hour fast charge
- Clean, dry, safe and streak-free floors
- Centrifugal water delivery
- Sustainably engineered from a minimum 45% recycled plastic, including accessories
- Part of the NX300 Pro Cordless Network
- Folds flat for easy storage
- 520x850x1132mm (WxLxH)

18L Tank Capacity	100W Vac Motor	400MM Deck Size	150RPM Brush Speed
Power 36V		Brush Motor 175W	
Recharge Time 1hr 80% / 2hrs 100%			
Brush Size 400mm		Runtime Up to 60mins	
Pad Size 360mm		Net Weight 34.0kg	

NEW TTB3045NX-R



- 70mins runtime
- 1-hour fast charge
- Compact machine, big results
- Hot-swapping between batteries
- Sustainably engineered from a minimum 45% recycled plastic, including accessories
- Part of the NX300 Pro Cordless Network
- 470x890x1100mm (WxLxH)

30L Tank Capacity	210W Vac Motor	450MM Deck Size	100RPM Brush Speed
Power 2x36V		Brush Motor 300W	
Recharge Time 1hr 80% / 2hrs 100%			
Brush Size 450mm		Runtime Up to 70mins	
Pad Size 400mm		Net Weight 79.0kg	

Note: Subject to region availability, please contact your Numatic representative for information.



See page 49 for more information

NEW 244NX-R **ReFlo**
TECHNOLOGY

70% LABOUR SAVING
80% LOWER WATER USE

The 244NX-R is lightweight and easy to use, leaving floors clean, dry, safe and streak-free, whilst reducing labour costs by 70% and water use by 80%.*

- Up to 80 mins Runtime
- 1 Hour Fast Charge
- NX300 36V Lithium Power
- "One Fits All" Battery
- Minimum 20% Recycled Plastic*

Easy to Use
Simple to set up and easy to use



Simple Fill
Removable clean tank with "No-Spill" Cap



Adjustable Water Flow
Easily adjustable water flow to suit cleaning needs



Foot-operated Brush Deck
Simple and easy to engage brush deck



Working in partnership with
charity: water

**EVERY 244NX FUNDS
5000L OF WATER TO
COMMUNITIES WHO
NEED IT.**

Since 2021, we have donated
85 Million
Litres of Water to Projects
Around the World.

See pages 6-7 for more information
or visit: numatic.com/charitywater



Watch the full video at:
numatic.com/244NX

*Time saving of 70% vs mopping / wage £11 per hour, 100sqm 7 days per week. Water use by 80% based on replacing 16L mopping system, cleaning 7 days per week.

Scan me

*20% represents the minimum use of recycled plastic in 244NX-R, including accessories.



Numatic
NU-Assist

See page 49
for more information

4x Longer Lasting than Lead Batteries

Runs Longer

Configurable performance that suits you, offering increased runtime of up to 44%*. Ensuring you can keep cleaning when it is most convenient for you.

More Sustainable

NX1K lasts longer than lead alternatives, significantly reducing material use and disposal, providing a much more sustainable solution.

Fast & Flexible Charging

Unlike Lead, NX1K Fast Charge Technology allows completely flexible charging, allowing you to use your machine whenever you need to, no matter how much it's charged. NX1K Fast Charge Technology drives productivity, providing you an increase in machine availability in comparison to Lead.

Extended Long Life Power

Delivering over 4000 charge cycles, NX1K will last as long as your machine. Utilising the latest Lithium Phosphate Technology, NX1K is one of the safest battery platforms on the market. A 3-year battery warranty provides complete peace of mind for you and your cleaning fleet.†

Nu-Track Insights

Built-in with our intelligent fleet management telemetry system, Nu-Track provides in-depth insights, lowering costs and increasing productivity across your fleet. ‡



*Any comparisons used are based on typical usage scenarios, results may differ. Performance comparisons use equivalent GelTec models.

†3-Year Warranty subject to terms and market availability, please contact Numatic for more information.

‡ Nu-Track subject to market / model availability.

NX1K Lithium Range



TBL4045

TBL6055T

CRL8072



“Investing in Lithium, compared to routinely replacing lead batteries and associated service costs, provides a positive return on investment across the NX1K Range, therefore saving you money.”

NX1K Lithium Range



TBL4045



- Compact design
- Powerful cleaning results
- Fast & flexible charging
- Configurable battery performance that suits you
- On-board charging
- 805x1155x1160mm (WxLxH)

40L Tank Capacity	400W Vac Motor	140RPM Brush Speed
Brush Motor 300W		Deck Size 450mm
Pad Size 400mm		Brush Size 450mm
1 x Battery		2 x Battery
Runtime 1hr 40mins		Runtime 3hrs 10mins
Recharge Time 2hrs 30mins		Recharge Time 5hrs
Net Weight 119.3kg		Net Weight 136.6kg

TBL4055



- Compact design
- Powerful cleaning results
- Fast & flexible charging
- Configurable battery performance that suits you
- On-board charging
- 948x1200x1160mm (WxLxH)

40L Tank Capacity	400W Vac Motor	140RPM Brush Speed
Brush Motor 300W		Deck Size 550mm
Pad Size 508mm		Brush Size 550mm
1 x Battery		2 x Battery
Runtime 1hr 38mins		Runtime 3hrs 9mins
Recharge Time 2hrs 30mins		Recharge Time 5hrs
Net Weight 113.9kg		Net Weight 124.7kg

TBL4055T



- Compact design
- Powerful cleaning results
- Fast & flexible charging
- Configurable battery performance that suits you
- On-board charging
- Traction drive makes cleaning inclines safer and easier
- 948x1200x1160mm (WxLxH)

40L Tank Capacity	400W Vac Motor	140RPM Brush Speed
Brush Motor 300W		Deck Size 550mm
Pad Size 508mm		Brush Size 550mm
Traction Drive 250W		Drive Speed 0-4km/h
1 x Battery		2 x Battery
Runtime 1hr 33mins		Runtime 3hrs 4mins
Recharge Time 2hrs 30mins		Recharge Time 5hrs
Net Weight 123.8kg		Net Weight 134.7kg

TBL6055



- Big capacity, compact design
- Clean, dry, safe floors in minutes
- Fast and flexible charging
- Stay cleaning for longer with over 3 hours runtime
- On-boarding charging
- 948x1425x1120mm (WxLxH)

60L Tank Capacity	400W Vac Motor	140RPM Brush Speed
Brush Motor 300W		Deck Size 550mm
Pad Size 508mm		Brush Size 550mm
1 x Battery		2 x Battery
Runtime 1hr 40mins		Runtime 3hrs 10mins
Recharge Time 2hrs 30mins		Recharge Time 5hrs
Net Weight 115.3kg		Net Weight 126.1kg

TBL6055T



- Big capacity, compact design
- Clean, dry, safe floors in minutes
- Fast and flexible charging
- Stay cleaning for longer with up to 3 hours runtime
- On-boarding charging
- Traction drive makes cleaning inclines safer and easier
- 948x1425x1120mm (WxLxH)

60L Tank Capacity	400W Vac Motor	140RPM Brush Speed
Brush Motor 300W		Deck Size 550mm
Pad Size 508mm		Brush Size 550mm
Traction Drive 250W		Drive Speed 0-4km/h
1 x Battery		2 x Battery
Runtime 1hr 30mins		Runtime 3hrs
Recharge Time 2hrs 30mins		Recharge Time 5hrs
Net Weight 141.1kg		Net Weight 152.0kg

TBL8572



- Dual brush design
- Powerful cleaning results
- Fast & flexible charging
- Configurable battery performance that suits you
- On-board charging
- 948x1513x1144mm (WxLxH)

85L Tank Capacity	400W Vac Motor	150RPM Brush Speed
Brush Motor 600W		Deck Size 720mm
Pad Size 2x360mm		Brush Size 2x370mm
Traction Drive 400W		Drive Speed 0-4.2km/h
2 x Battery		3 x Battery
Runtime 3hrs		Runtime 4hrs 30mins
Recharge Time 5hrs		Recharge Time 7hrs 30mins
Net Weight 204.1kg		Net Weight 214.9kg

NX1K battery platform powers commercial grade TwinFlo vacuum and brush motor for unrivaled cleaning performance, even in the most demanding environments.



- 1 CRL8072
- 2 TBL4045
- 3 TBL6055T

CRL8055



- Compact design
- Powerful cleaning results
- Fast and flexible charging
- Stay cleaning for longer
- On-board charging
- 805x1460x1160mm (WxLxH)

80L Tank Capacity	400W Vac Motor	150RPM Brush Speed
Brush Motor 600W		Deck Size 550mm
Pad Size 508mm		Brush Size 550mm
Traction Drive 400W		Drive Speed 0-6km/h
1 x Battery		2 x Battery
Runtime 1hr 20mins		Runtime 2hrs 40mins
Recharge Time 2hrs 30mins		Recharge Time 5hrs
Net Weight 139.8kg		Net Weight 150.6kg

CRL8072



- Compact design
- Best in class scrub width
- Fast and flexible charging
- Stay cleaning for longer
- On-board charging
- 948x1450x1160mm (WxLxH)

80L Tank Capacity	400W Vac Motor	150RPM Brush Speed
Brush Motor 600W		Deck Size 720mm
Pad Size 2x360mm		Brush Size 2x370mm
Traction Drive 400W		Drive Speed 0-6km/h
1 x Battery		2 x Battery
Runtime 1hr 20mins		Runtime 2hrs 40mins
Recharge Time 2hrs 30mins		Recharge Time 5hrs
Net Weight 159.8kg		Net Weight 170.6kg

TRL720



- User-friendly controls
- Dual brush design
- Fast and flexible charging
- Configurable battery performance that suits you
- On-board charging
- 948x1676x1425mm

120L Tank Capacity	600W Vac Motor	150RPM Brush Speed
Brush Motor 600W		Deck Size 720mm
Pad Size 2x360mm		Brush Size 2x370mm
Traction Drive 700W		Drive Speed 0-6.5km/h
3 x Battery		4 x Battery
Runtime 4hrs		Runtime 5hrs 20mins
Recharge Time 7hrs 30mins		Recharge Time 10hrs
Net Weight 282.6kg		Net Weight 293.4kg

TVL850



- User-friendly controls
- Trio adjustable brush design
- Configurable battery performance that suits you
- On-board charging
- 1054x1676x1425mm











120L Tank Capacity	600W Vac Motor	212RPM Brush Speed
Brush Motor 3 x 400W		Deck Size 650/750/850mm
Pad Size 3x300mm		Brush Size 3x300mm
Traction Drive 700W		Drive Speed 0-6.5km/h
3 x Battery		4 x Battery
Runtime 3hrs 5mins		Runtime 4hrs 10mins
Recharge Time 7hrs 30mins		Recharge Time 10hrs
Net Weight 287.0kg		Net Weight 298.4kg

5 x Battery & 6 x Battery configurations available for TRL720 and TVL850

Hurricane / NuSpeed

Accessories & TwinTec Blades

Using genuine Numatic accessories will ensure you achieve the best results from your FloorCare machine.

 <p>HFM Solution Tank PN: 606890</p>	 <p>NLL Solution Tank PN: 606101</p>	 <p>244NX Solution Tank PN: 913825</p>
 <p>HFM / HNS Optional Spraytec Kit PN: 606325</p>	 <p>HFM Dustrol Kit (Grey) PN: 906412</p> <p>HNS1550 Dustrol Kit (Grey) PN: 906414</p> <p>HFM Dustrol Control Brush Ring (Standard with Dustrol Kits) PN: 606079</p>	 <p>HNS / HFM Micro HEPA Filter Dustrol Kit (Grey) PN: 913060</p>
 <p>HFM 10kg Weight PN: 606077</p>	<p>HFM Dustrol Kit (Grey) PN: 906412</p> <p>HNS1550 Dustrol Kit (Grey) PN: 906414</p> <p>HFM Dustrol Control Brush Ring (Standard with Dustrol Kits) PN: 606079</p>	<p>HNS / HFM Micro HEPA Filter Dustrol Kit (Grey) PN: 913060</p>
 <p>244NX Replacement Blade Set (2-Pieces) PN: 913810</p>	 <p>TT1840G / TTB1840NX Replacement Blade Set (2-Pieces) PN: 903531</p>	 <p>TTB3045NX / TT4045G / TBL4045 / CRL8055 / CRL8072 / TVL850 (805mm) PN: 900518</p> <p>TT4055G / TBL4055/T / TBL6055/T / TBL8572 / TRL720 / TVL850 (944mm) PN: 900519 (1053mm) PN: 900520</p> <p>Replacement Polyurethane Blade Set</p>

TwinTec

Tools & Accessories

 <p>Aluminium Floor Tool Blades Included 244NX PN: 913830</p>	 <p>Plastic Floor Tool Blades Included TT1840G / TTB1840NX PN: 903532</p>	 <p>Aluminium Floor Tool Adjustable Wheels & Blades Included TTB3045NX / TT4045G / TBL4045 / CRL8055 / CRL8072 / TVL850 (650mm) PN: 904691</p> <p>TT4055G / TBL4055/T / TBL6055/T / TBL8572 / TRL720 / TVL850 (750mm) PN: 904699 (850mm) PN: 904209</p>
 <p>All TT / TTB / TBL Machines Wander Floor Kit (32mm) (Except TT1840G / TTB1840NX) PN: 607250</p>	 <p>All TT / TTB / TBL Machines Wander Floor Kit (38mm), (Except TT1840G / TTB1840NX) PN: 606193</p>	 <p>CRL Machines Wander Floor Kit (38mm), C/W Fitting Kit PN: 903183</p>
 <p>TwinTec Emptying Hose 32mm Emptying Hose Kit PN: 609100</p>	 <p>244NX Transport Wheel Set PN: 914088</p>	 <p>TwinTec Castor Plate Aluminium Floor Tool Wide Angle Adjustable Castor Plate Upgrade Kit PN: 908028</p>
 <p>Cable Roll Extension for Mains Machines 20m Cable Roll Extension UK PN: 612002 EUR PN: 612003</p>	 <p>NX300 Battery PN: 913686</p> <p>NX300 Charging Dock PN: 911334</p> <p>NX300 Dual Charging Dock PN: 910820</p> <p>NX300 Mains Cable for Charging Docks UK PN: 912365 EURO PN: 912361 SWISS PN: 912364 AUS/NZ PN: 912360 USA PN: 912362 S.AFRICA PN: 912363 JPN PN: 913041</p>	 <p>NX300 Dual Charging Dock with Mains Cable UK PN: 915748 EURO PN: 915749 SWISS PN: 915750 AUS/NZ PN: 915751 USA PN: 915752 S.AFRICA PN: 915753 JPN PN: 915754</p>
 <p>CRL Spray Mop Mounting Kit PN: 903182</p>	<p>Look out for the logo to make sure you're getting a Genuine Numatic Part.</p> 	 <p>CRL Caddy Kit (Red) PN: 902505</p>

VersaCare

Raising cleaning standards and productivity with versatility, innovation and quality.

VersaCare Contents

Mop Kits	64-65
MULTI-Matic Range	66-69
ECO-Matic Range	70-73
SERVO-Matic Range	74-77
PRO-Matic Range	78-82
SRK Kits	83
Carousel Range	85
NuBag Range	86-87
NuKeeper Range	88-93
NuKeeper Top Tray & Hood Kits	94
NuKeeper End Frame Kits	95



The MULTI-Matic trolley range designed for enhanced usability, productivity and simplicity.

See pages 66-69 for details.



Mop Kits

PCM403 POLYSTATIC 3-PIECE MOP SET



- C/W 50 x PolyStatic Mop Cloths
- Disposable PolyStatic Mop "Gripper" Pad
- Velcro Fixing
- Pad Size 400mm

PCM401 POLYSTATIC 1-PIECE MOP SET



- C/W 50 x PolyStatic Mop Cloths
- Disposable PolyStatic Mop "Gripper" Pad
- Velcro Fixing
- Pad Size 400mm

PCT400 POLYSTATIC TELESCOPIC MOP SET



- C/W 50 x PolyStatic Mop Cloths
- Disposable PolyStatic Mop "Gripper" Pad
- Velcro Fixing
- Pad Size 400mm

PSM400G POLYSTATIC SPRAYMOP SET



- C/W 50 x PolyStatic Mop Cloths
- C/W Disposable PolyStatic Mop "Gripper" Pad
- C/W 400ml Bottle
- Velcro Fixing
- Pad Size 400mm

DTK1 KENTUCKY MOP SET



- C/W 1 x Kentucky 400g Mop
- Suitable for Vertical Press

DTK2 POCKET MOP SET



- C/W 1 x BluTec Microfibre Pocket Mop
- Suitable for Vertical Press, Wide Press and MopMatic
- Pocket Fixing
- Pad Size 400mm

DTK3 HANG-ON MOP SET



- C/W 1 x BluTec Microfibre Mop
- Suitable for Vertical Press
- Hang-on Fixing
- Pad Size 400mm

DTK4 VELCRO MOP SET



- C/W 1 x BluTec Microfibre Mop
- Suitable for Wide Press and MopMatic
- Velcro Fixing
- Pad Size 400mm

DTK6G SPRAYMOP MASTER SET



- C/W 1 x BluTec Microfibre Pocket Mop
- C/W 400ml Bottle
- Pocket Fixing
- Pad Size 400mm

DTK8G SPRAYMOP MASTER SET



- C/W 1 x BluTec Microfibre Velcro Mop
- C/W 400ml Bottle
- Velcro Fixing
- Pad Size 400mm

DTK9 TWIST MOP



- C/W 1 x Bactiguard Mop

DTK10 MULTIMOP



- C/W 1 x Sponge
- Folding Press
- Velcro Fixing
- Sponge Size 350mm

DTK12G WING MOP PUMP ACTION SET



- C/W 1 x BluTec Microfibre Pocket Mop
- Suitable for Vertical Press, Wide Press and MopMatic
- Pocket Fixing
- Pad Size 400mm

DTK13G WING MOP PUMP ACTION SET



- C/W 1 x BluTec Microfibre Hang-on Mop
- Suitable for Vertical Press
- Hang-on Fixing
- Pad Size 400mm

POLYSTATIC GRIPPER PAD



- Disposable PolyStatic Mop "Gripper" Pad

POLYSTATIC MOP DUSTERS



- Fits on PCM403, PSM400G
- Pack of 50 x PolyStatic Mop Cloths (White / Red / Blue / Green / Yellow)
- Carton of 400 x PolyStatic Mop Cloths, (8 x 50) (White / Red / Blue / Green / Yellow)
- C/W 2 x "Gripper" Pads

COLOUR-CODED MOP PRESS CLIPS

- 4 Colour Options
- For Use on Mops and Presses
- Easy to Attach & Remove
- Available in Packs of 10



The MidMop is always on-hand and easily stored, with a compact design providing a go-anywhere twin-bucket mopping system.



MMB1616 shown with Optional Mop Stand and DTK13G Mop Set Consumables for illustration purposes only.

MM30G



- C/W 1 x Sponge
- Velcro Fixing
- 30L Capacity Bucket
- Folding Press
- Castors: 4 x 50mm
- Pad Size 350mm
- 340x475x320mm (WxLxH)

HB1812R



- Vertical Press for Flat or Kentucky/Twist Mop
- 18L Clean Capacity / 12L Dirty Capacity
- Optional Mop Kits: DTK1 / DTK2 / DTK3 / DTK12G / DTK13G
- Castors: 4 x 75mm
- 410x560x800mm (WxLxH)

MMB1616



- Vertical Press for Flat or Kentucky/Twist Mop
- 16L Clean Capacity / 16L Dirty Capacity
- Optional Mop Kits: DTK1 / DTK2 / DTK3 / DTK12G / DTK13G
- Optional Handle
- Castors: 4 x 75mm
- 510x680x1020mm (WxLxH)

MULTI-Matic Trolley Range

Designed for enhanced usability, productivity and simplicity, MULTI-Matic offers a choice of 9 models to suit any cleaning task or environment.



Numatic
Nu-Design
Bespoke Janitorial
See page 9



ReFlo
TECHNOLOGY

Made from Recycled Plastic
ReFlo Technology uses the highest quality recycled plastic, delivering the same Numatic reliability, durability and quality as always.

COMPACT & VERSATILE MOPPING TROLLEY

MM0



MM1



MM2



MM3



MM4

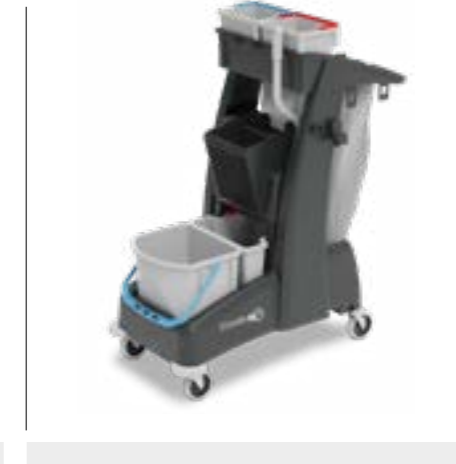

MM5

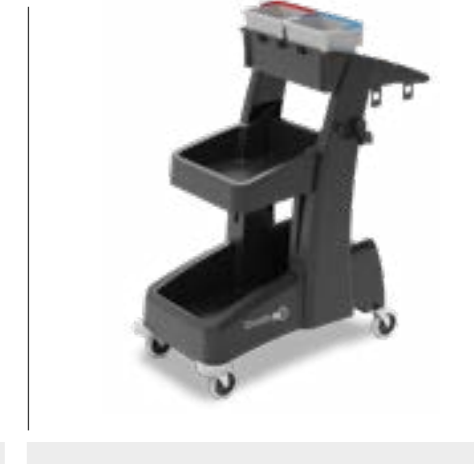

MM6

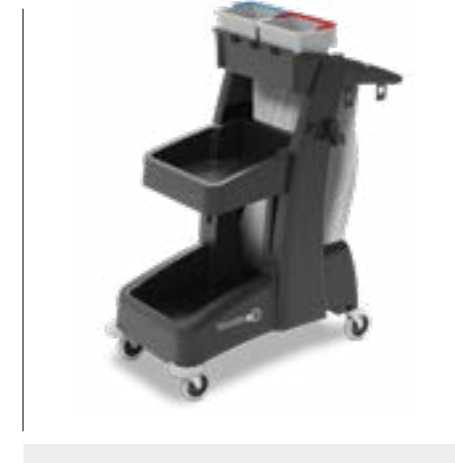

MM7

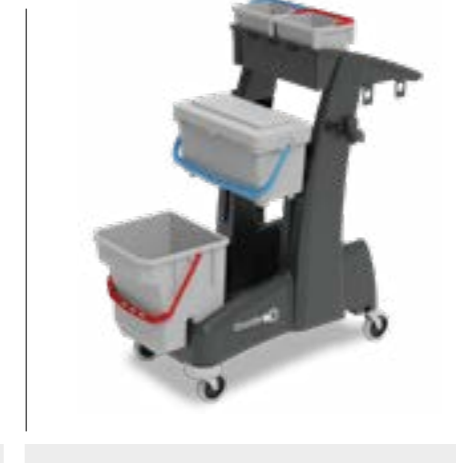

MM8

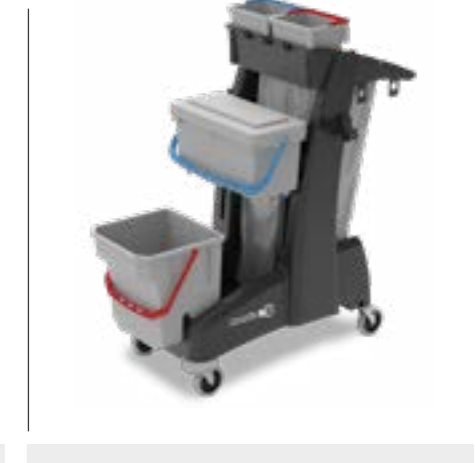

MODEL	MM0	MM1	MM2	MM3	MM4	MM5	MM6	MM7	MM8
Waste	-	-	70L	-	70L	-	70L	-	70L
Storage Options	-	-	-	-	-	Shelf	Shelf	-	-
Castors	4 x 75mm	4 x 75mm	4 x 75mm	4 x 75mm	4 x 75mm	4 x 75mm	4 x 75mm	4 x 75mm	4 x 75mm
Dolly Mop Basket	-	Yes	Yes	-	-	-	-	-	-
Press	-	-	-	Vertical Press	Vertical Press	-	-	-	-
Buckets	-	2 x 5L	2 x 5L	2 x 5L	2 x 5L	2 x 5L	2 x 5L	2 x 5L	2 x 5L
Mop Bucket	-	1 x 28L	1 x 28L	1 x 15 / 1 x 17L	1 x 15 / 1 x 17L	-	-	1 x Dosed, 1 x 28L	1 x Dosed, 1 x 28L
Hooks	-	1 x Large T-Slot Hook	1 x Large T-Slot Hook	1 x Large T-Slot Hook	1 x Large T-Slot Hook	1 x Large T-Slot Hook	1 x Large T-Slot Hook	1 x Large T-Slot Hook	1 x Large T-Slot Hook
Clips	-	1 x T-Slot Mopstick Clip	1 x T-Slot Mopstick Clip	1 x T-Slot Mopstick Clip	1 x T-Slot Mopstick Clip	1 x T-Slot Mopstick Clip	1 x T-Slot Mopstick Clip	1 x T-Slot Mopstick Clip	1 x T-Slot Mopstick Clip
Dimensions (WxLxH) (MM)	480x940x1130	480x940x1130	480x940x1130	480x940x1130	480x940x1130	480x940x1130	480x940x1130	480x940x1130	480x940x1130

MULTI-Matic Mop Kits & Accessories

5L SWING BUCKET  <ul style="list-style-type: none"> 5L Swing Bucket, Red Handle PN: 905225 5L Swing Bucket, Blue Handle PN: 905226 5L Swing Bucket, Green Handle PN: 905227 5L Swing Bucket, Yellow Handle PN: 905228 	5L SWING BUCKET LID  <ul style="list-style-type: none"> Lid for 5L Swing Bucket, Clear PN: 902108 	5L SWING BUCKET KIT  <ul style="list-style-type: none"> 5L Bucket Holder C/W Fixing, Black PN: 629050 5L Swing Bucket Kit, Red Handle PN: 906277 5L Swing Bucket Kit, Blue Handle PN: 906278 5L Swing Bucket Kit, Green Handle PN: 906279 5L Swing Bucket Kit, Yellow Handle PN: 906280 	15L TWINMOP BUCKET  <ul style="list-style-type: none"> 15L TwinMop Bucket, Red Handle PN: 905221 15L TwinMop Bucket, Blue Handle PN: 905222 15L TwinMop Bucket, Green Handle PN: 905223 15L TwinMop Bucket, Yellow Handle PN: 905224 	
17L FRONT MOP BUCKET  <ul style="list-style-type: none"> 1 x 17L Bucket, Blue Handle Used on: MM3 / 4 PN: 915058 	15L REAR MOP BUCKET  <ul style="list-style-type: none"> 1 x 15L Bucket, Red Handle Used on: MM3 / 4 PN: 915057 	28L TWINMOP BUCKET  <ul style="list-style-type: none"> 28L TwinMop Bucket, Red Handle PN: 905217 28L TwinMop Bucket, Blue Handle PN: 905218 28L TwinMop Bucket, Green Handle PN: 905219 28L TwinMop Bucket, Yellow Handle PN: 905220 Used on: MM1 / 2 / 7 / 8 	MOP BASKET  <ul style="list-style-type: none"> Dolly Mop Basket PN: 906729 	WASTE BAG SECURING MOULDING  <ul style="list-style-type: none"> Used on: MM2 / 4 / 6 / 8 PN: 913978
WASTE BIN LID  <ul style="list-style-type: none"> Used on: MM2 / 4 / 6 / 8 PN: 913979 	TOP STORAGE TRAY  <ul style="list-style-type: none"> Used on: MM1 / 3 / 5 / 7 PN: 913981 	MID STORAGE TRAY  <ul style="list-style-type: none"> Used on: MM5 / 6 PN: 915060 	MB400 MOP DOSING LID ASSEMBLY  <ul style="list-style-type: none"> Dosed Mop Bucket Lid Used on: MM7 / 8 PN: 915406 	MB400 MOP DOSING BUCKET  <ul style="list-style-type: none"> Dosed Mop Bucket, Blue Handle Used on: MM7 / 8 PN: 915407
MB400 MOUNTING BRACKET  <ul style="list-style-type: none"> Dosed Mop Bucket Bracket Frame Used on: MM7 / 8 PN: 915613 	VERTICAL MOP PRESS  <ul style="list-style-type: none"> Flat Mop Press Used on: MM3 / 4 PN: 915326 Kentucky/Twist Mop Press Used on: MM3 / 4 PN: 915237 	WHEEL KIT  <ul style="list-style-type: none"> Large Wheel Kit PN: 915320 	FABRIC WASTE BAG  <ul style="list-style-type: none"> Multi-pocket for Convenient Storage PN: 915319 	75MM CASTOR X1  <ul style="list-style-type: none"> Castor x1 204118
GREY CADDY  <ul style="list-style-type: none"> Carry Cleaning Products PN: 628437 	TWIN 1L BOTTLE HOLDER  <ul style="list-style-type: none"> Twin 1L Bottle Holder, ReFlo Black PN: 910375 	MOP SUPPORT KIT  <ul style="list-style-type: none"> 1 x Mop Support for on-board Mop Storage PN: 915321 	LARGE & SMALL T-SLOT HOOK  <ul style="list-style-type: none"> A - Large T-Slot Hook (x1) PN: 911936 A - Large T-Slot Hook (x10) PN: 912547 B - Small T-Slot Hook (x1) PN: 915171 B - Small T-Slot Hook (x10) PN: 915325 	MOP CLAMP & CLIP  <ul style="list-style-type: none"> C - T-Slot Clamp (x1) PN: 912528 C - T-Slot Clamp (x10) PN: 912529 D - Mopstick Clip (x1) PN: 629874 D - Mopstick Clip (x10) PN: 629883

WET FLOOR SIGN



- Wet Floor Sign with Tray-Fix Hooks, Yellow A - PN: 629044
- Wet Floor Sign, Yellow, English B - PN: 901457

PCM403 POLYSTATIC 3-PIECE MOP SET



- 50 x PolyStatic Mop Cloths
- Disposable PolyStatic Mop "Gripper" Pad
- Velcro Fixing
- Suitable for Vertical Press Pad Size 400mm PN: 629813

DTK1 KENTUCKY MOP SET



- 1 x Kentucky 400g Mop
- Suitable for Vertical Press PN: 629332

DTK2 POCKET MOP SET



- 1 x BluTec Microfibre Pocket Mop
- Suitable for Vertical Press, Wide Press and MopMatic
- Pocket Fixing
- Pad Size 400mm PN: 629333

DTK3 HANG-ON MOP SET



- 1 x BluTec Microfibre Mop
- Suitable for Vertical Press
- Hang-on Fixing
- Pad Size 400mm PN: 629334

DTK9 TWIST MOP



- 1 x Bactiguard Mop PN: 906460

DTK12G WING MOP PUMP ACTION SET



- 1 x BluTec Microfibre Pocket Mop
- Suitable for Vertical Press, Wide Press and MopMatic
- Pocket Fixing
- Pad Size 400mm PN: 906205

DTK13G WING MOP PUMP ACTION SET



- 1 x BluTec Microfibre Hang-on Mop
- Suitable for Vertical Press
- Hang-on Fixing
- Pad Size 400mm PN: 909278



A compact and versatile trolley range, ensuring productivity with a choice of janitorial solutions and mopping options to suit all environments.

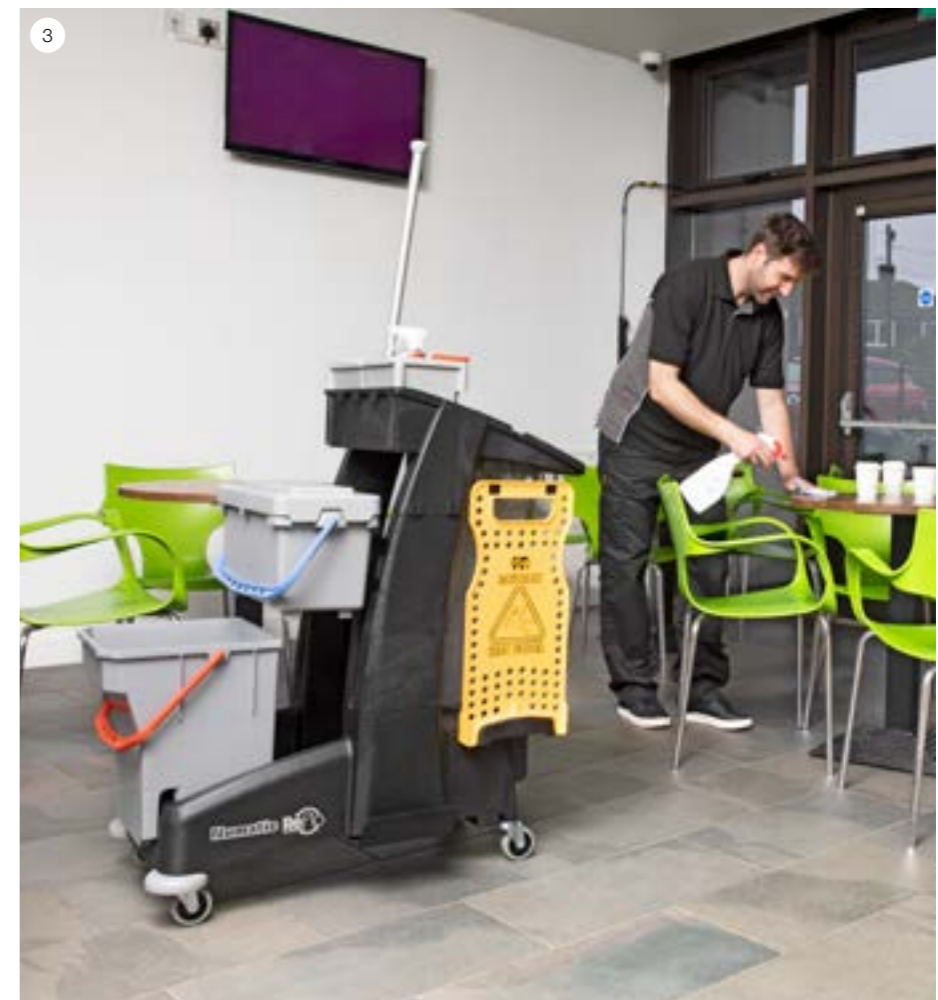

1 Compact, convenient and easy to store when not in use
 2 & 3 Open shelf storage for easy access to all your cleaning equipment and supplies on the move

ECO-Matic Trolley Range

Sustainably engineered using the highest quality recycled plastic, each model in the ECO-Matic range benefits from 100% Structofoam construction, making it tough, easy to clean and built to last.

The best value cleaning trolley range on the market.

- Ergonomically Designed
- Sustainably Engineered
- Built to Last

Numatic
Nu-Design
Bespoke Janitorial
See page 9



Made from Recycled Plastic

ReFlo Technology uses the highest quality recycled plastic, delivering the same Numatic reliability, durability and quality as always.

MOPPING STORAGE & WASTE

EM1



EM2



EM3



EM4



EM5



EM6



EM6 with Kit SRK22 and Optional Wet Floor Sign. Consumables for illustration purposes only.

EM1 with Kit SRK14 and SRK21. Consumables for illustration purposes only.

EM3 with Kit SRK16 / SRK16K and Optional Wet Floor Sign. Consumables for illustration purposes only.

MODEL	EM1	EM2	EM3	EM4	EM5	EM6
Waste	120 / 2 x 70L	120 / 2 x 70L	120 / 2 x 70L	2 x 120 / 4 x 70L	120 / 2 x 70L	2 x 120 / 4 x 70L
Storage Options	Shelf	2 x Deep Drawers	Shelf	Shelf	2 x Deep Drawers	2 x Deep Drawers
Castors	4 x 100mm	4 x 100mm	4 x 100mm	4 x 100mm	4 x 100mm	4 x 100mm
Kits	SRK14 / 20 / 21 / 22	SRK14 / 20 / 21 / 22	SRK15 / 16 / 19 / 20 / 21 / 22	SRK 20 / 21 / 22	SRK15 / 16 / 19 / 20 / 21 / 22	SRK20 / 21 / 22
Optional Security	-	Lockable Drawers	-	-	Lockable Drawers	Lockable Drawers
Optional SprayMop	Yes	Yes	-	-	-	-
Wall and Door Buffers	Yes	Yes	Yes	Yes	Yes	Yes
Dimensions (WxLxH) (MM)	545x900x1000	545x900x1000	545x1160x1000	545x1230x1000	545x1160x1000	545x1230x1000

ECO-Matic Trolley Range

**ALL-IN-ONE
READY TO GO
COMPACT SOLUTION**

Offers an all-in-one, ready to go compact solution

- Compact Design
- Convenient Storage
- Sustainably Engineered



Numatic
Design

Bespoke Janitorial
See pages 9



EM2-TM with Kits SRK14, SRK22 and DTK9 Twist Mop. Consumables for illustration purposes only.



EM1-TM with Kits SRK14, SRK22 and DTK9 Twist Mop. Consumables for illustration purposes only.

EM1-TM



EM2-TM



MODEL	EM1-TM	EM2-TM
Waste	120 / 2 x 70L	120 / 2 x 70L
Storage Options	Shelf	2 x Deep Drawers
Castors	4 x 100mm	4 x 100mm
Kits	SRK14 / 22 / DTK9	SRK14 / 22 / DTK9
Optional Security	-	Lockable Drawers
Wall and Door Buffers	Yes	Yes
Dimensions (WxLxH) (MM)	545x900x1000	545x900x1000

ECO-Matic Mop Kits & Accessories

KIT SRK14



- 1 x 18L Blue Handle Bucket, Grey
- C/W Mop Basket
- Used on: EM1 / EM2
PN: 910439

KIT SRK15



- 1 x 34L Blue Handle Bucket, Grey
- C/W Mop Basket
- Used on: EM3 / EM5
PN: 910440

KIT SRK16 / SRK16K



- Vertical Press for Flat or Kentucky/Twist Mop
- 1 x 17L Red Handle Bucket, Grey
- 1 x 17L Blue Handle Bucket, Grey
- Used on: EM3 / EM5
Flat Mop Press PN: 910442
Kentucky Mop Press PN: 910443

KIT SRK19 BAG FRAME KIT



- 1 x ReFlo Bag Frame with Fixing Screws
- 1 x ReFlo Bag Securing Frame
- 1 x Grey Lid
- C/W Colour-coded Discs
- Used on: EM3 / EM5
PN: 910843

KIT SRK20



- Rear Wheel Assembly
- Used on: EM Range
PN: 910758

KIT SRK21



- 4 x 5L Swing Pails
- 5L Swing Pail Handle, Red / Blue / Green / Yellow
- Used on: EM Range
PN: 910898

KIT SRK22



- 2 x 10L Buckets, Grey
- 10L Bucket Handle, Red / Blue
- Used on: EM Range
PN: 911401

MOP CLIPS



- Mopstick Clip (x1)
ReFlo Black PN: 629874
- Mopstick Clip (x10)
ReFlo Black PN: 629883
- Used on: EM Range

LARGE T-SLOT HOOK, SMALL T-SLOT HOOK

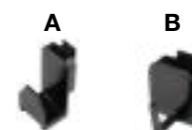

- Large (x1) A - PN: 911936
- Large (x10) A - PN: 912547
- Small (x1) B - PN: 915171
- Small (x10) B - PN: 915325

ECO-MATIC BAG SPLITTER KIT



- 1 x Bag Splitter with Fixing Screws for Dual Waste
- 1 x Bag Trapper Extrusion
- C/W Bags
- C/W Roll of 70L Waste Bags
- C/W Colour-coded Discs
- Used on: EM Range
PN: 910840

MOP SUPPORT KIT



- 1 x Mop Support for On-board Mop Storage
- Used on: EM Range
PN: 915321

ZIPPED LAUNDRY BAG



- 1 x Zipped Laundry Bag
- Used on: EM Range
PN: 909369

WET FLOOR SIGN



- Wet Floor Sign Assembly, Yellow, English
- Used on: EM Range
PN: 901457

DTK9 TWIST MOP



- C/W 1 x Bactiguard Mop
- Used on: EM Range
PN: 906460

NUMATIC QUICK TROLLEY BRACKET



- 1 x Numatic Quick Trolley Bracket
- Used on: EM Range
PN: 916341



- Robust design to protect the Numatic Quick
- Easy to fit
- Compact in size
- Integrated non-marking buffers for wall and door protection



SERVO-Matic Trolley Range

SERVO-Matic offers a choice of 7 base units and a range of kits and accessories for limitless configurations.

Selecting the perfect fit is easy with SERVO-Matic.

- Increase Productivity
- Exceptionally Tough
- Sustainably Engineered



SM1405 with Kit SRK1. Consumables for illustration purposes only.

SMX1415 with Kit SRK3 and Optional Wet Floor Sign. Consumables for illustration purposes only.



COMPACT STORAGE & WASTE TROLLEY

SM RANGE

SM1405



SM1415



SM1705



SM5



SMX RANGE

SMX1405



SMX1415



SMX1705



MODEL	SM1405	SM1415	SM1705	SMX1405	SMX1415	SMX1705	SM5
Waste	120 / 2 x 70L	120 / 2 x 70L	120 / 2 x 70L	120 / 2 x 70L	120 / 2 x 70L	120 / 2 x 70L	120 / 2 x 70L
Storage Options	-	Divided Tray	Storage Drawer	-	Divided Tray	Storage Drawer	Storage Drawer
Optional Castors	100 / 125mm & Braked	100 / 125 / 200mm & Braked	100 / 125 / 200mm & Braked	100 / 125mm & Braked	100 / 125 / 200mm & Braked	100 / 125 / 200mm & Braked	125mm
Kits	Multiple Options	Multiple Options	Multiple Options	Multiple Options	Multiple Options	Multiple Options	-
Buckets	2 x 5L	2 x 6L	4 x 5L or 2 x 10L	2 x 5L	2 x 6L	4 x 5L or 2 x 10L	-
Bin Surround	-	-	-	Yes	Yes	Yes	-
Dimensions (WxLxH) (MM)	570x835x970	570x1090x1115	570x1325x1115	570x835x970	570x1090x1115	570x1325x1115	570x1120x1115



Made from Recycled Plastic

ReFlo Technology uses the highest quality recycled plastic, delivering the same Numatic reliability, durability and quality as always.

Numatic Nu-Design Bespoke Janitorial

See page 9



- Select your Trolley Base
- Pick your Storage Options
- Choose your Accessories
- Submit your Configuration

Visit: numaticsupport.com/nu-design

SERVO-Matic Mop Kits & Accessories

KIT SRK0 / SRK0K



- Vertical Press for Flat or Kentucky/Twist Mop
- 1 x 15L Red Handle Bucket, Grey
- 1 x 15L Blue Handle Bucket, Grey
- Used on: SM/SMX Range Flat Mop Press PN: 910413 Kentucky/Twist Mop Press PN: 910414

KIT SRK1 / SRK1K



- Vertical Press for Flat or Kentucky/Twist Mop
- 1 x 17L Red Handle Bucket, Grey
- 1 x 17L Blue Handle Bucket, Grey
- 1 x Bucket Support Tray
- Used on: SM/SMX Range Flat Mop Press PN: 910415 Kentucky/Twist Mop Press PN: 910416

KIT SRK2 / SRK2K



- Vertical Press for Flat or Kentucky/Twist Mop
- 1 x 22L Red Handle Bucket, Grey
- 1 x 22L Blue Handle Bucket, Grey
- 1 x Extension Tray
- Used on: SM1415 / 1705 / SMX1415 / 1705 Flat Mop Press PN: 910425 Kentucky/Twist Mop Press PN: 910426

KIT SRK3



- Speedclean Wide Press
- 1 x 22L Red Handle Bucket, Grey
- 1 x 22L Blue Handle Bucket, Grey
- 1 x Extension Tray
- Used on: SM1415 / 1705 / SMX1415 / 1705 PN: 910430

KIT SRK4



- 1 x MopMatic2 Bucket, Grey
- C/W Set of Colour-coded Discs
- 1 x 22L Red Handle Bucket, Grey
- 1 x Extension Tray
- C/W 2.5L Dosing Bottle
- Used on: SM1415 / 1705 / SMX1415 / 1705 PN: 910433

KIT SRK5



- 2 x MopMatic2 Bucket, Grey
- C/W Set of Colour-coded Discs
- 1 x Extension Tray
- C/W 2.5L Dosing Bottle
- Used on: SM1415 / 1705 / SMX1415 / 1705 PN: 910435

KIT SRK6



- 2 x MopMatic2 Bucket, Grey
- C/W Set of Colour-coded Discs
- 1 x 22L Red Handle Bucket, Grey, C/W Lid
- MopMatic2 Hang-on Frame, Nutex
- 1 x Extension Tray
- C/W 2.5L Dosing Bottle
- Used on: SM1415 / 1705 / SMX1415 / 1705 PN: 910436

KIT SRK62



- Hood Set
- Lockable
- Used on: SM1705 / SMX1705 PN: 910315

MIDMOP OPTION MMB1616



- Vertical Press for Flat or Kentucky/Twist Mop
- 510x680x1020mm (WxLxH)
- Used on: SM1415 / 1705 / SMX1415 / 1705

KIT SRK26



- Optional Doors C/W Locks and Hinges
- Used on: SM1705 / SMX1705 PN: 908171

KIT SRK30



- Optional Single Door and Back C/W Locks and Hinges
- Used on: SM1705 / SMX1705 PN: 911444

KIT SRK50 / 51



- Optional Bin Surround Kit
- SRK50 Used on: SMX1405 912849
- SRK51 Used on: SMX1415 912853

BAG SPLITTER KIT



- 1 x Bag Splitter with Fixing Screws for Dual Waste
- C/W Roll of 70L Waste Bags
- C/W Colour-coded Discs
- Used on: SM / SMX Range PN: 910880

NUMATIC QUICK TROLLEY BRACKET



- 1 x Numatic Quick Trolley Bracket
- Used on: SM / SMX Range PN: 916341

MB400 MOUNTING BRACKET



- Optional Attachment For use with MB400 Dosed Mop Bucket
- Used on: SM / SMX Range PN: 916646

CUSTOMISABLE DOOR PANELS

KIT SRK27

- Door Graphic Set No.1 Happy Cleaning PN: 908172

KIT SRK28

- Door Graphic Set No.2 Big Ben PN: 908173

KIT SRK29

- Door Graphic Set No.3 Sunflowers PN: 908174

For a personalised door panel with your logo, get in touch today to find out more.



SMX1415 with Kit SRK3 and Kit SRK29 Door Panel Option. Consumables for illustration purposes only.



SM1705 with Kit SRK6 and Kit SRK22, with 2 x Shallow Storage Drawers and 1 x Deep Storage Drawer. Consumables for illustration purposes only.

PRO-Matic Trolley Range

The PRO-Matic range offers a 100% configurable cleaning system, increasing operator usability and productivity.

Unlimited configuration options with complete versatility.

- Fully Customisable
- Safe & Secure
- Sustainably Engineered

NUMATIC
Design
Bespoke Janitorial
See page 9

A choice of 12 base units and a wide-range of kits and accessories, no detail goes unmissed with PRO-Matic; meeting the precise requirements of any user, in any environment, for any application.



1 Safe and Secure Storage
2 Drawer Storage Options

REMOVABLE BIN FEATURE



Removable Bin Feature
Completely detachable and manoeuvrable swing-out bin for convenient waste removal. Colour-coding options available for effective infection control.

CONFIGURABLE, SAFE & SECURE



MINIMUM 50% RECYCLED CONTENT
POST-CONSUMER
PRE-CONSUMER

PM10



PM11



PM12



PM20



PM21



PM22



PM30



PM31



PM32



MODEL	PM10	PM11	PM12	PM20	PM21	PM22	PM30	PM31	PM32
Waste	1 x 120L / 2 x 70L	1 x 120L / 2 x 70L	2 x 120L / 4 x 70L	1 x 120L / 2 x 70L	1 x 120L / 2 x 70L	2 x 120L / 4 x 70L	1 x 120L / 2 x 70L	1 x 120L / 2 x 70L	2 x 120L / 4 x 70L
Storage Drawers	-	Optional	-	Optional	Optional	Optional	Optional	Optional	Optional
Doors	-	Optional	-	Optional	Optional	Optional	Optional	Optional	Optional
Castors Size	Optional	Optional	Optional	Optional	Optional	Optional	Optional	Optional	Optional
Detachable Wheeled Bin	Yes	Yes	Yes	Yes	Yes	Yes	Yes	Yes	Yes
Kits	Multiple Options	Multiple Options	Multiple Options	Multiple Options	Multiple Options	Multiple Options	Multiple Options	Multiple Options	Multiple Options
Dimensions (WxLxH) (MM)	580x972x1073	580x972x1073	580x972x1073	580x1335x1073	580x1335x1073	580x1335x1073	580x1700x1073	580x1700x1073	580x1700x1073



Made from Recycled Plastic

ReFlo Technology uses the highest quality recycled plastic, delivering the same Numatic reliability, durability and quality as always.

Nu-Design

Nu-Design guides you through the product configuration process, providing a visual output and configuration breakdown at each selection.

See page 9



CONFIGURABLE CLEANING SYSTEMS

Visit: numaticsupport.com/nu-design

PRO-Matic Trolley Range

The PM13 provides a lockable and manoeuvrable solution.

A completely configurable cleaning system with a wide choice of features to suit operator usability and productivity. Ready for anything, always on the go and on-hand wherever you need it.

PM13



- Optional Castors
- Optional Doors
- Optional Storage Drawers
- 580x972x1073mm (WxLxH)



PM13 with SRK21 and SRK22 Kits, 2 x Deep Storage Drawers and 4 x Shallow Storage Drawers and Lockable Doors. Consumables for illustration purposes only.

PM13 OPTIONAL CONFIGURATIONS



- 2 x Deep Storage Drawers
- 4 x Shallow Storage Drawers
- 6 x Storage Box Runners
- Castors: 4 x 100mm
- Lockable Doors
- 4 x 5L Pails
- 2 x 10L Buckets
- 580x972x1073mm (WxLxH)



- 2 x Deep Storage Drawers
- 4 x Shallow Storage Drawers
- 6 x Storage Box Runners
- Castors: 4 x 100mm
- 580x972x1073mm (WxLxH)



- 2 x Deep Storage Drawers
- 4 x Shallow Storage Drawers
- 6 x Storage Box Runners
- Castors: 4 x 100mm
- Lockable Doors
- Industry Colour-coding
- 580x972x1073mm (WxLxH)

The PRO-Matic PM24 and PM34 provide a lockable multi-waste recycling system, offering the options to separate your waste responsibly with a choice of 3 or 4 industry colour-coded bins.

Nu-Design

Bespoke Janitorial

See pages 9



PM34 with SRK21 and SRK22 Kits and SRK29 Door Panel Kits. Consumables for illustration purposes only.



PM24 with SRK21 and SRK22 Kits and SRK28 Door Panel Kits. Consumables for illustration purposes only.

PM24



- Waste 3 x 120L / 6 x 70L
- End Detachable Wheeled Bins and Central Static Bin
- Optional Castors
- Lockable Doors
- Industry Colour-coding
- 580x1335x1073mm (WxLxH)

PM34



- Waste 4 x 120L / 8 x 70L
- End Detachable Wheeled Bins and Central Static Bins
- Optional Castors
- Lockable Doors
- Industry Colour-coding
- 580x1700x1073mm (WxLxH)



MINIMUM 50% RECYCLED CONTENT
POST-CONSUMER
PRE-CONSUMER

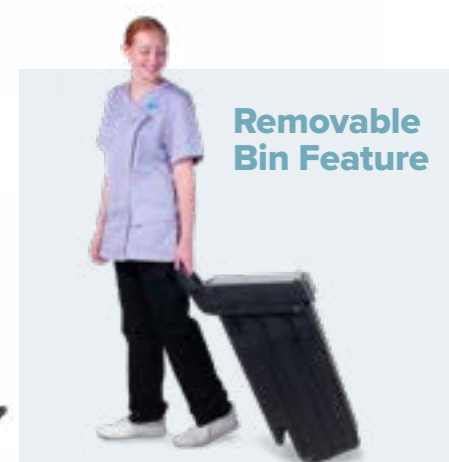

Removable Bin Feature

Completely detachable and manoeuvrable swing-out bin for convenient waste removal. Colour-coding options available for effective infection control.

PRO-Matic Mop Kits & Accessories

KIT SRK1S / SRK1KS



- Vertical Press for Flat or Kentucky/Twist Mop
- 1 x 17L Red Handle Bucket, Grey
- 1 x 17L Blue Handle Bucket, Grey
- 1 x Bucket Support Tray
- Used on: PM10 / 20 / 30
- Flat Mop Press PN: 909523
- Kentucky/Twist Mop Press PN: 910348

KIT SRK2S / SRK2KS



- Vertical Press for Flat or Kentucky/Twist Mop
- 1 x 22L Red Handle Bucket, Grey
- 1 x 22L Blue Handle Bucket, Grey
- 1 x Extension Tray
- Used on: PM10 / 20 / 30
- Flat Mop Press PN: 909524
- Kentucky/Twist Mop Press PN: 910349

KIT SRK3S



- Speedclean Wide Press with Stainless Steel Handle
- 1 x 22L Red Handle Bucket, Grey
- 1 x 22L Blue Handle Bucket, Grey
- 1 x Extension Tray
- Used on: PM10 / 20 / 30
- PN: 909525

KIT SRK4



- 1 x MopMatic2 Bucket, Grey
- C/W Set of Colour-coded Discs
- C/W 2.5L Dosing Bottle
- 1 x 22L Red Handle Bucket, Grey
- 1 x Extension Tray
- Used on: PM10 / 20 / 30
- PN: 910433

KIT SRK5



- 2 x MopMatic2 Buckets, Grey
- C/W Set of Colour-coded Discs
- C/W 2.5L Dosing Bottle
- 1 x Extension Tray
- Used on: PM10 / 20 / 30
- PN: 910435

KIT SRK6S



- 2 x MopMatic 2 Buckets, Grey
- C/W Set of Colour-coded Discs
- C/W 2.5L Dosing Bottle
- 1 x 22L Red Handle Bucket, Grey, C/W Lid
- MopMatic2 Hang-on Frame, Stainless Steel
- 1 x Extension Tray
- Used on: PM10 / 20 / 30
- PN: 909526

MIDMOP OPTION MMB1616



- Vertical Press for Flat or Kentucky/Twist Mop
- 510x680x1020mm (WxLxH)
- Used on: PM10 / 20 / 30

KIT SRK62S



- Hood Set
- Lockable
- Used on: PM Range
- PN: 910316

KIT SRK26



- Optional Doors
- C/W Locks and Hinges
- Used on: PM11 / 13 / 20 / 21 / 22 / 30 / 31 / 32
- PN: 908171

KIT SRK30



- Optional Single Door and Back Panel
- C/W Locks and Hinges
- Used on: PM11 / 13 / 20 / 21 / 22 / 30 / 31 / 32
- PN: 911444

KIT SRK31



- Optional Double Doors and 2 x Back Panels
- C/W Locks and Hinges
- Used on: PM13 / 21 / 30 / 31 / 32
- PN: 911447

KIT SRK49



- Swing-out Bin
- Used on: PM10 / 11 / 12 / 20 / 21 / 22 / 30 / 31 / 32
- PN: 912815

BAG SPLITTER KIT



- 1 x Bag Splitter with Fixing Screws for Dual Waste
- C/W Roll of 70L Waste Bags
- C/W Colour-coded Discs
- Used on: PM Range
- PN: 912817

NUMATIC QUICK TROLLEY BRACKET



- 1 x Numatic Quick Trolley Bracket
- Used on: PM Range
- PN: 916341



CUSTOMISABLE DOOR PANELS

KIT SRK27

- Door Graphic Set No.1 Happy Cleaning
- PN: 908172

KIT SRK28

- Door Graphic Set No.2 Big Ben
- PN: 908173

KIT SRK29

- Door Graphic Set No.3 Sunflowers
- PN: 908174



For a personalised door panel with your logo, get in touch today to find out more.

SRK Kits

KIT	PART No.	EM1	EM2	EM3	EM4	EM5	EM6	SM1405	SM1415	SM1705	SMX1405	SMX1415	SMX1705	PM10	PM11	PM12	PM13	PM20	PM21	PM22	PM30	PM31	PM32
SRK0	910413							●	●	●	●	●	●										
SRK0K	910414							●	●	●	●	●	●										
SRK1	910415							●	●	●	●	●	●										
SRK1K	910416							●	●	●	●	●	●										
SRK1S	909523													●				●				●	
SRK1KS	910348													●				●				●	
SRK2	910425							●	●			●	●										
SRK2K	910426							●	●			●	●										
SRK2S	909524													●				●				●	
SRK2KS	910349													●				●				●	
SRK3	910430							●	●			●	●										
SRK3S	909525													●				●				●	
SRK4	910433							●	●			●	●	●				●				●	
SRK5	910435							●	●			●	●	●				●				●	
SRK6	910436							●	●			●	●										
SRK6S	909526													●				●				●	
SRK8	911222							●	●			●	●	●				●				●	
SRK14	910439	●	●																				
SRK15	910440			●		●																	
SRK16	910442			●		●																	
SRK16K	910443			●		●																	
SRK19	910843			●		●																	
SRK20	910758	●	●	●	●	●	●																
SRK21	910898	●	●	●	●	●	●			●			●	●	●	●	●	●	●	●	●	●	●
SRK22	911401	●	●	●	●	●	●			●			●	●	●	●	●	●	●	●	●	●	●
SRK26	908171									●			●		●		●	●	●	●	●	●	●
SRK27	908172									●			●		●		●	●	●	●	●	●	●
SRK28	908173									●			●		●		●	●	●	●	●	●	●
SRK29	908174									●			●		●		●	●	●	●	●	●	●
SRK30	911444									●			●		●		●	●	●	●	●	●	●
SRK31	911447																●		●		●	●	●
SRK35S	909072																	●	●	●	●	●	●
SRK36S	909073																				●	●	●
SRK42S	909075																						
SRK43S	909076																			●			
SRK44S	909232																						●
SRK49	912815													●	●	●		●	●	●	●	●	●
SRK50	912849							●															
SRK51	912853									●													
SRK62	910315									●			●										
SRK62S	910316												●	●	●	●	●	●	●	●	●	●	●



Made from Recycled Plastic

ReFlo Technology uses the highest quality recycled plastic, delivering the same Numatic reliability, durability and quality as always.



Carousel Range

The Carousel Range features removeable caddy storage and versatile waste for everyday cleaning solutions.

NC0R



- Waste 70L
- 2 x 5L Swing Pails
- C/W SprayMop Master and Tray
- Castors: 4 x 80mm
- 480x545x890mm (WxLxH)

NC1R



Image shows NC1R-TM

- Waste 70L
- 1 x 4L Small Caddy
- 14L Bucket and Dolly Mop Basket
- Castors: 4 x 80mm
- Optional Twist Mop (NC1R-TM)
- 480x545x890mm (WxLxH)

NC2R



- Waste 2 x 70L
- Castors: 4 x 80mm
- 480x545x890mm (WxLxH)

NC3R



- Waste 70L
- 1 x 4L Small Caddy
- 1 x 10L Large Caddy
- Castors: 4 x 80mm
- 480x545x890mm (WxLxH)

NC4R



- 2 x 4L Small Caddy
- 2 x 10L Large Caddy
- Castors: 4 x 80mm
- 480x545x890mm (WxLxH)



NC0R with 2 x 5L Swing Pails, SprayMop Master and Tray. Consumables for illustration purposes only.



Made from Recycled Plastic

ReFlo Technology uses the highest quality recycled plastic, delivering the same Numatic reliability, durability and quality as always.



NuBag Range

The NuBag range has been designed to provide space saving answers with super strong construction and a smaller capacity when needed.

Twin waste, linen and laundry modules have always been popular in commercial establishments. The dual-end design can incorporate waste and laundry, linen and laundry or waste and linen.

SAX120PR



NSX240R



LLT200R



NBT200R



NB3002R / AT



Big in use, small in storage, the Servo-X trolley range will always find favour in the many locations where space is at an absolute premium.



- 1 NX1002 (Consumables for illustration purposes only)
- 2 X Fold Design for Compact Storage
- 3 Integrated Laundry Bag Closure System

NX1001



NX1002



NX1501



NX2001



NX2401



MODEL	SAX120PR	NSX240R	LLT200R	NBT200R	NB3002R / AT
Waste	1 x 120L	2 x 120L	2 x 100L	2 x 100L	1 x 100L + 1 x 200L
Castor Size	4 x 75mm	4 x 75mm	4 x 75mm	4 x 75mm	4 x 200mm
Dimensions (WxLxH) (MM)	655x550x910	580x780x965	580x780x965	580x780x860	655x1110x1115

MODEL	NX1001	NX1002	NX1501	NX2001	NX2401
Waste	100L	2 x 100L	150L	200L	240L
Castor Size	4 x 75mm	4 x 75mm	4 x 75mm	4 x 75mm	4 x 75mm
Dimensions (WxLxH) (MM)	390x460x960	460x760x960	460x760x760	460x760x960	550x780x960

NuKeeper Range

NKS Single & Low Level

Compact, considered and capable...
The NKS range will always be
a welcome addition to housekeeping
where space is at a real premium.



NKS1LLR

Consumables for illustration purposes only.



- 1 Folding Bag Ends and Heavy-duty Construction
- 2 Easily Detachable Laundry Bags
- 3 Flexi-Front Enclosure
- 4 Numatic Quick Trolley Bracket



MINIMUM 50% RECYCLED CONTENT
POST-CONSUMER
PRE-CONSUMER

COMPACT LAUNDRY FLEXI-FRONT

NKS1LLR

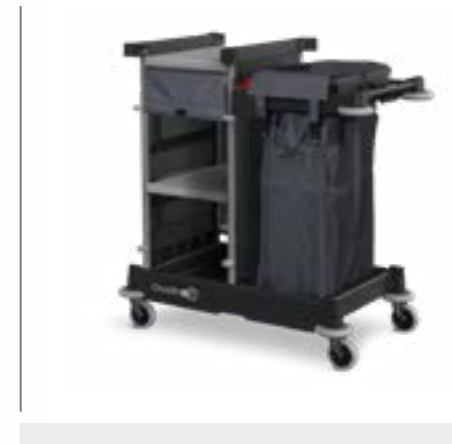

NKS2LLR



NKS1R

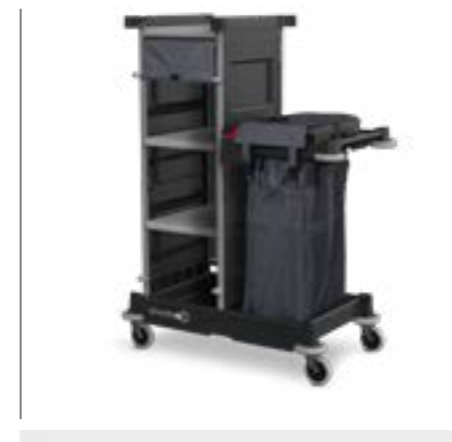

NKS2R



Numatic Nu-Design

Bespoke Janitorial
See pages 9

MODEL	NKS1LLR	NKS2LLR	NKS1R	NKS2R
Waste	1 x 100L	2 x 100L	1 x 100L	2 x 100L
Castor Size	4 x 100mm	4 x 100mm	4 x 100mm	4 x 100mm
Height	Low Level	Low Level	Full Height	Full Height
Storage	1 x Shelf	1 x Shelf	2 x Shelves	2 x Shelves
Dimensions (WxLxH) (MM)	582x998x1026	582x1420x1026	582x998x1352	582x1420x1352

NuKeeper Range

NKT Twin & Low Level

Compact in size... Big on storage. The NKT range has a Flexi-Front enclosure, rotating side buffers to protect walls and even a Low Level (LL) version when visibility during transit is a consideration.



Made from Recycled Plastic

ReFlo Technology uses the highest quality recycled plastic, delivering the same Numatic reliability, durability and quality as always.



MINIMUM 50% RECYCLED CONTENT
POST-CONSUMER
PRE-CONSUMER

COMPACT LAUNDRY FLEXI-FRONT

NKTOR



NKT1R

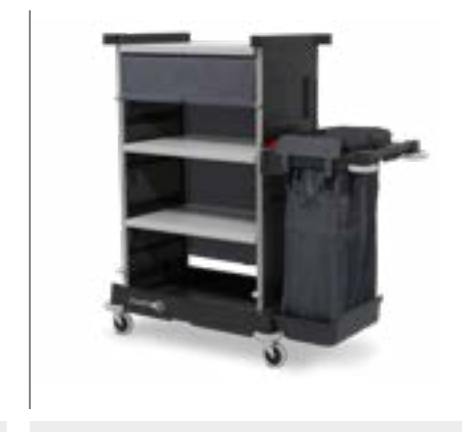

NKT2R



NKTOLLR



NKT1LLR



NKT2LLR



Consumables for illustration purposes only.

Nu-Design

Bespoke Janitorial

See pages 9

MODEL	NKTOR	NKT1R	NKT2R	NKTOLLR	NKT1LLR	NKT2LLR
Waste	-	1 x 100L	2 x 100L	-	1 x 100L	2 x 100L
Castor Size	4 x 100mm	4 x 100mm	4 x 100mm	4 x 100mm	4 x 100mm	4 x 100mm
Height	Full Height	Full Height	Full Height	Low Level	Low Level	Low Level
Storage	2 x Twin Shelves	2 x Twin Shelves	2 x Twin Shelves	1 x Twin Shelf	1 x Twin Shelf	1 x Twin Shelf
Dimensions (WxLxH) (MM)	582x940x1352	582x1361x1352	582x1783x1352	582x940x1026	582x1361x1026	582x1783x1026

Easily Detachable Laundry Bags



NuKeeper Range

NKU Professional Universal

The NuKeeper Universal has been designed in every way for demanding hotel cleaning regimes, tackling narrow corridors, heavy loads and the pressures of time sensitive public-space day cleaning.



MINIMUM 50% RECYCLED CONTENT
POST-CONSUMER
PRE-CONSUMER

NKU32RFF
(Flexi-Front with
Hood Kit NKA8R)



NKU32RHF
(Hard-Front with
Optional Trays)

Consumables for illustration purposes only.

NKU30RFF



NKU30RHF



NKU31RFF



NKU31RHF



NKU32RFF



NKU32RHF



SPACE-SAVING
CUSTOMISABLE
SECURE



Nu-Design
Bespoke Janitorial
See pages 9

1 NKU31RHF with Top Kit NKA11R
2 Lockable Tablet Option
3 Flexi-Front System
Consumables for illustration purposes only.

MODEL	NKU30RFF	NKU30RHF	NKU31RFF	NKU31RHF	NKU32RFF	NKU32RHF
Waste	-	-	1 x 100L	1 x 100L	2 x 100L	2 x 100L
Castor Size	4 x 200mm All-Terrain	4 x 200mm All-Terrain	4 x 200mm All-Terrain	4 x 200mm All-Terrain	4 x 200mm All-Terrain	4 x 200mm All-Terrain
Closure	Flexi-Front	Hard-Front Bi-fold Doors	Flexi-Front	Hard-Front Bi-fold Doors	Flexi-Front	Hard-Front Bi-fold Doors
Security	-	Lockable	-	Lockable	-	Lockable
Storage	1 x Twin Shelf	1 x Twin Shelf	1 x Twin Shelf	1 x Twin Shelf	1 x Twin Shelf	1 x Twin Shelf
Dimensions (WxLxH) (MM)	667x1116x1205	667x1116x1205	667x1532x1205	667x1532x1205	667x1948x1205	667x1948x1205

NuKeeper Top Tray & Hood Kits

A complete range of accessory kits provide the specification you need with no compromise.

<p>NKA1</p>  <ul style="list-style-type: none"> 1 x Tray with Lid 1 x Tray with Divisions and Lid 1 x Half Tray PN: 903698 	<p>NKA2</p>  <ul style="list-style-type: none"> 2 x Tray with Divisions and Lid 1 x Half Tray PN: 903699 	<p>NKA3</p>  <ul style="list-style-type: none"> 2 x Tray with Lid 1 x Half Tray PN: 903700
<p>NKA4</p>  <ul style="list-style-type: none"> 1 x Tray 1 x Tray with Divisions 1 x Half Tray PN: 903701 	<p>NKA5</p>  <ul style="list-style-type: none"> 2 x Tray 1 x Half Tray PN: 903702 	<p>NKA6</p>  <ul style="list-style-type: none"> 2 x Tray with Divisions 1 x Half Tray PN: 903703
<p>NKA7R</p>  <ul style="list-style-type: none"> 1 x Hood Set 1 x Half Tray PN: 913415 	<p>NKA8R</p>  <ul style="list-style-type: none"> 2 x Hood Set 1 x Half Tray PN: 913416 	<p>NKA9R</p>  <ul style="list-style-type: none"> 1 x Hood Set 1 x Tray with Lid 1 x Half Tray PN: 913417
<p>NKA10R</p>  <ul style="list-style-type: none"> 1 x Hood Set 1 x Tray with Divisions and Lid 1 x Half Tray PN: 913418 	<p>NKA11R</p>  <ul style="list-style-type: none"> 1 x Hood Set 1 x Tray 1 x Half Tray PN: 913419 	<p>NKA12R</p>  <ul style="list-style-type: none"> 1 x Hood Set 1 x Tray with Divisions 1 x Half Tray PN: 913420

NKA13 TOP KIT



- Top Kit - Laundry Support Set
- PN: 907145

NKU3R2FF
(Flexi-Front shown with Hood Kit NKA12R)



For illustration purposes, all tray kits are shown in location on trolley.

NuKeeper End Frame Kits

<p>NKA100PR</p>  <ul style="list-style-type: none"> Bag Capacity 1 x 100L Optional Moulded Laundry Bag Extension Kit PN: 913190 	<p>NKA100PAR</p>  <ul style="list-style-type: none"> Bag Capacity 1 x 100L Optional Moulded Laundry Bag Extension Kit Adjustable Handle PN: 910627 	<p>NKA101PR</p>  <ul style="list-style-type: none"> Waste 1 x 120L Optional Moulded Full Waste Bag Extension Kit C/W 3-Piece Lid Set, Black PN: 913376
<p>NKA102PR</p>  <ul style="list-style-type: none"> Waste 1 x 140L / 2 x 70L Optional Moulded Twin Waste Bag Extension Kit C/W Split Lid Set, Red / Blue PN: 913395 	<p>NKA103PR</p>  <ul style="list-style-type: none"> Waste 1 x 120L Optional Moulded Linen Bag Extension Kit C/W 3 Piece Lid Set, Black PN: 913397 	<p>NKA140PR</p>  <ul style="list-style-type: none"> Waste 1 x 120L Optional Moulded Full Waste Bag Extension Kit C/W iPad / Tablet Storage Lid Set, Black PN: 913400
<p>NKA109UR</p>  <ul style="list-style-type: none"> Optional Vacuum Storage Platform and Support Frame Kit, Black Used on: NKU Models Only PN: 913402 	<p>NKA111UR</p>  <ul style="list-style-type: none"> Optional End Kit Twin End Half Tray Kit, Black Used on: All NKS / NKT / NKU Models PN: 913409 	<p>NKA112UR</p>  <ul style="list-style-type: none"> Optional End Kit Twin End Full Tray Kit, Black Used on: All NKS / NKT / NKU Models PN: 913411
<p>NKA120R</p>  <ul style="list-style-type: none"> Optional End Kit SprayMop Tray Kit, Black Used on: All NKS / NKT / NKU Models PN: 913412 	<p>NKA130UR</p>  <ul style="list-style-type: none"> Optional End Kit 30 Litre Waste Bin Kit, Black Used on: All NKS / NKT / NKU Models PN: 913413 	<p>NUMATIC QUICK TROLLEY BRACKET</p>  <ul style="list-style-type: none"> 1 x Numatic Quick Trolley Bracket Used on: All NKS / NKT / NKU Models PN: 916341



Numatic Performance You Can Trust.

Head Office
Numatic International Limited
Chard, Somerset TA20 2GB
UNITED KINGDOM

Tel: 01460 68600
numatic.com

TO VIEW OUR
SUSTAINABILITY
REPORT VISIT
OUR WEBSITE HERE

[numatic.co.uk/
sustainability](http://numatic.co.uk/sustainability)

