



World Class Leaders in Fire Detection Since 1918



PRODUCT CATALOG

EN Fire Detection Systems



World Class Leaders In Fire Detection Since 1918

| Our History Timeline

The dates below have been carefully identified as some of the key events in Hochiki's history and together to help identify who Hochiki are today.

April 2, 1918

Japan's first fire alarm manufacturer was established under the corporate name of "Tokyo Hochiki Co., Ltd." at Yurakucho, Kojimachi-ku (now Chiyoda-ku), Tokyo under the investments mainly by life insurance companies. The prospectus tells us that the Company had been established for the purpose of "manufacturing fire, theft and other alarms and selling modern fire-fighting machinery."

- 1920** The world's first addressable fire alarm system was installed by Hochiki Corporation
- 1951** Hochiki produced a rate-of-rise heat detector & succeeded developing an automatic fire detector
- 1967** Hochiki develop an ionisation detector
- 1972** Tokyo Hochiki Co. Ltd became Hochiki Corporation and Hochiki America Corporation opened in the USA
- 1973** An intrinsically safe fire alarm system was developed
- 1975** Hochiki detectors first sold in the UK
- 1993** Hochiki Europe office opened in Gillingham, Kent
- 1995** Hochiki Corporation opened one of the largest testing facilities in the world
- 1996** Hochiki developed the highly reliable and robust ESP protocol
- 1997** Hochiki Singapore Branch Office was opened
- 2001** Hochiki representative office opened in Beijing
- 2010** Hochiki release UK's first intelligent emergency lighting system, FIREscape
- 2011** Hochiki Australia opened
- 2012** The Hochiki Group acquired Kentec Electronics and Hochiki de Mexico S.A. de C.V. was established
- 2013** Hochiki Middle East opened in Dubai
- 2013** Hochiki (Thailand) Co. Ltd opened in Bangkok, Thailand
- 2013** Hochiki Jakarta Rep. Office opened in Jakarta, Indonesia
- 2014** Hochiki Asia Pacific Pte Ltd established
- 2014** Hochiki India Branch Office opened in New Delhi
- 2017** Hochiki Ho Chi Minh Rep. Office opened in HCMC, Vietnam
- 2017** Hochiki Italia established in Verona, Italy. Hochiki release the innovative L@titude fire panel
- 2018** Hochiki release the ACD-E, CO multi-sensor
- 2019** Hochiki Manila Rep. Office opened in Manila, Philippines
- 2022** Hochiki Hanoi Rep. Office opened in Hanoi, Vietnam

 **HOCHIKI**

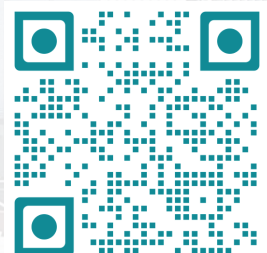

COMPANY OVERVIEW

Established in Japan 1918, Hochiki is an independent, multi-national, publicly listed company with over 2000 employees across the globe. One of the world's leading manufacturers of commercial and industrial fire detection and emergency lighting solutions, Hochiki has acquired global acceptance as the benchmark for high-integrity and long-term reliability.

Hochiki's facilities in Japan, the United States of America and Europe design and manufacture products and provide technical support suited to local standards and customer requirements. Total commitment to meeting the needs of individual national markets has reinforced the company's global reputation, resulting in Hochiki products being installed in many prestigious sites and in over 80 countries worldwide.

Hochiki Europe (UK) Ltd manufactures and distributes product for Europe, the Middle East, CIS, Indian Sub-Continent and Africa and is dedicated to providing sales and technical services to these markets.

As the regional hub for sales activities in Southeast Asia, Hochiki Asia Pacific holds a long history in Singapore before formally being established as "Hochiki Asia Pacific Pte. Ltd."

Presently, Hochiki Asia Pacific has one subsidiary and four representative offices.

91%

Respondents rated product quality as either 'very good' or 'excellent'

92%

Customers stated our market reputation is 'very good' or 'excellent'

88%

Customers are most likely to recommend our products

*STATS TAKEN FROM THE HOCHIKI CUSTOMER SERVICE SURVEY



L@TITUDE (LIFE SAFETY PLATFORM)



The Latitude range of fire alarm control equipment combines the very latest hardware and software to produce a control and indication system, which is powerful and sophisticated, yet simple to use and understand.

FEATURES

- 2 to 8 loop or 2 to 16 loop versions
- 5.25 A or 10.25 A, power supply options
- 3 programmable inputs
- 5 programmable relay outputs
- Hard wired fire and fault routing inputs and outputs
- Modular electronics
- 6400 max sub address points per panel
- Option to “invert” inputs and outputs
- Powerful, standard configuration templates
- Network up to 32 panels*
- Configurable via USB port to PC or memory stick

*Latitude is approved for networks up to 32 panels
(approval for networking up to 127 panels pending)

The flexibility of the Latitude platform is such that it can be re-configured to realise many other control and indication applications, with direct integration into intelligent buildings.

The Latitude platform is designed to add value to System Designers, Integrators, Service Providers and End Users/Building Owners. Developed from the ground up by Hochiki’s leading design team and using some of the most advanced technology available, Latitude is designed as one of the most powerful, intelligent and technically robust fire alarm products available.

The products and services offered under the Latitude brand provide solutions to the most technically challenging applications in life safety.

The modular nature of the Latitude system allows all field wiring to be connected to a passive mother board enabling addition, re-configuration or replacement of all electronic hardware without the need to disconnect any field wiring.

This modularity also allows each panel to be customised with addressable loop detection circuits, conventional detection circuits, relay cards, additional sounder outputs or programmable I/O modules as required.

ANALOGUE ADDRESSABLE (2-16 LOOP CONTROL PANEL)

With the increasing demands for power in fire detection and alarm systems, L@titude Fire Control panels are well placed to meet current and future needs.

All panels are available with either a 5.25A, 24V power supply capable of charging up to 26Ah batteries or a 10.25A, 24V power supply capable of charging up to 45Ah batteries. L@titude Fire Panels can be supplied with a range of remote power supply units making the control panel smaller and easier to install.

Up to 500 milliamps is available for each detection loop allowing for a generous quantity of loop powered devices. The four sounder circuits are each capable of supplying up to 2.5A at 24V to audio and audio visual devices (PSU dependant).

L@titude Media Gateway also provides the interface between control systems and other products and utilities such as PC graphics.

Configurable LAN connection to BMS system using Modbus or BACnet protocols via our Vizulinx Module.

L@titude fire systems are scalable with L@titude Net Enhances High Speed Networking. This allows up to 32 panels to be connected together as a fully fault tolerant networked system with rapid inter panel communications and up to 1.2km of standard two core fire resistant cabling between nodes. Each panel can be configured to display all or any events from any other panel allowing master/slave, multiple master/slave or peer to peer configuration.

Sophisticated network analysis tools provide the ability to identify connection problems instantly and the commissioning mode allows individual panels to be prevented from transmitting events to the network while maintaining communications.

L@TITUDE VISION NETWORK REPEATER



The L@titude Vision Network Repeater allows a full display and optional control of the L@titude fire alarm control panel from a small and unobtrusive local control station network repeater.

FEATURES

- Robust, full colour, 7" 800 x 480 touch screen graphical display
- Full indication of all information displayed at the fire control panel
- Automatic display brightness adjustment
- (Silenceable) internal sounder
- Connections Via: Panel Network
- Low current, 24 VDC powered
- Slim compact construction
- Configurable functionality
- Configurable languages
- Enable Key-switch

L@TI-VIEW (Software Solution)

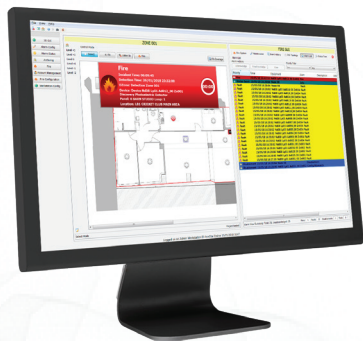

Powerful and Sophisticated Software Solution

No situation requires a more urgent response than a fire event. On a large public site, especially during busy periods, public safety is paramount.

A powerful and sophisticated software solution, L@ti-View gives building managers complete monitoring and control over fire detection, providing a comprehensive fire risk and incident management system. Where time is of the essence, site managers can respond quickly and efficiently to a fire event. L@ti-View plays a crucial role in safeguarding people, vitally important information and property.

FEATURES

- Supports dual screens, allowing a dedicated screen for the 2D location images and a separate screen for listing active events and system management
- Powerful event log filtering and reporting
- Manage the state of the fire system using a combination of graphical images and system controls
- Full map navigation using configurable buttons or map areas
- Perform device and zone disablements/enabements

LOOP EXPLORER 2 (LE2) CONFIGURATION SOFTWARE

Loop Explorer 2, PC configuration software provides a familiar, simple to use PC application with the power to produce the most complex configurations via an easy to use and intuitive interface. A Standard USB port allows configurations stored on a USB memory stick to be loaded to the control panel without the use of a PC.

Logical operators such as COINCIDENCE, AND, OR, NOT, TIME OF DAY and INTERVAL TIME along with the ability to group inputs and outputs into collections other than zones and the capability to configure up to 2,000 zones produces a system capable of fulfilling in the most demanding of control applications.

Loop Explorer 2 itself is highly configurable allowing customisation of languages, colour schemes and company logos and allowing exposure to single or multiple devices databases to be set for each other.

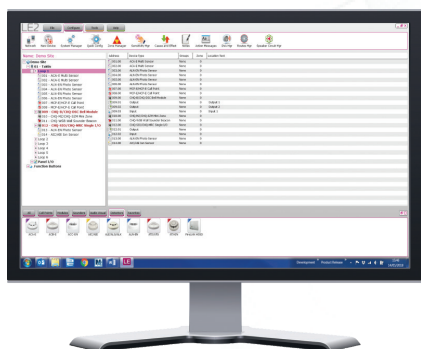

FEATURES

- Based on the industry leading Loop Explorer
- Delivered and managed via the new virtualresource.global website
- No more out of date version in circulation
- Many new features and benefits
 - System Manager
 - Loop Manager
- Up to 5,000 Cause and Effect options
- Additional C & E operators
- "Not" and Time
- Powerful templates
- Favourite device tab
- Language support

VIZULINX (Fire Alarm Management Solution)

FEATURES

- Multi-functional gateway for use with Hochiki fire alarm systems
- Configuration through embedded web server - no additional software required
- EZ configuration feature enables quick and easy starting startup
- Remote notification of fire alarm system status / events via e-mail
- E-mail messages are user customisable to suit requirements
- System integration capabilities via Modbus TCP/IP or BACnet IP protocols*
- Downloadable diagnostic information
- Field upgradeable firmware
- Operates on a AM3354 CPU 300-800 Mhz Processor /512 MB RAM
- Compatible with the current range of Hochiki addressable and conventional panels using IP, Serial or GPIO connectivity



Highly configurable using an embedded web server and EZ configuration wizard Vizulinx provides a whole range of options for remote monitoring and system integration of Hochiki fire alarm systems.

Email Notification can provide immediate notification to managers, staff, maintenance and service engineers of a change in panel status i.e. alarm, fault etc. wherever they are. Earlier notification enables a more effective response which can reduce system downtime and improve false alarm management.

Format of e-mail messages are user configurable, information shown in the message can be customised as required.

Integration of Hochiki fire alarm systems with other building equipment such as controllers for ventilation, lifts etc. is essential and Vizulinx provides easily configurable solutions using Modbus TCP/IP or BACnet IP protocols.

Vizulinx enables Hochiki fire alarm systems to send status messages to other equipment which are part of Building Management (BMS) or Building Automation and Control systems using the above protocols.

Modbus

Up to 9999 Modbus addresses can be configured on Vizulinx relating to Panel, Zone and Loop device status. For addressable systems 500 Panel status, 500 Zone status and 1000 pre-configured loop device addresses are provided free with the Vizulinx module.

Additional Modbus addresses can be unlocked on the Vizulinx module by purchase of a Modbus license update code, each license will unlock an additional 1000 Modbus addresses.

BACnet

Uses Object IDs to identify panels, zones and devices, on a BACnet protocol network. Vizulinx provides 2000 zone object IDs, 128 panel object IDs and 500 object IDs for loop devices (Separate Object IDs are allocated to addresses and sub-addresses).

Additional object IDs for loop addresses and sub-addresses can be unlocked by purchase of a BACnet upgrade license code, each license code will provide an additional 500 object IDs.

L@TITUDE CONNECTION DIAGRAM (Initial Setup and Expandability Guide)

L@titude Addressable Control Panel 2 - 8 Loop / 2 - 16 Loop



L@titude Addressable Control Panel
is available in GREY / RED / BLACK

Comes as standard with:

1 Loop Card
(2 Loops per card)



With space for up to 4 Loop Cards
(each card provides 2 Loops)



Network Card allows 32
L@titude Repeaters/Panels
to be added to the network



Media Gateway card allows
connection to Vizulinx and
L@ti-View

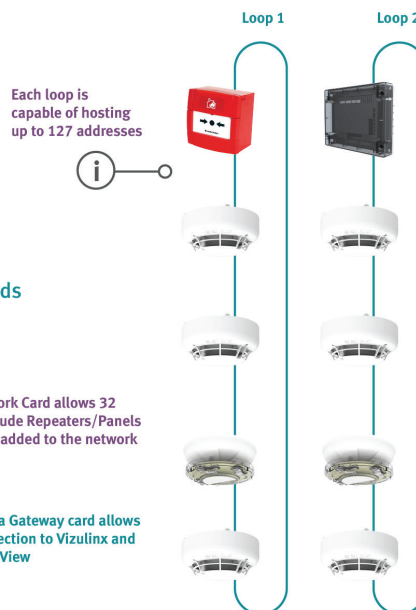

16 Channel I/O Module

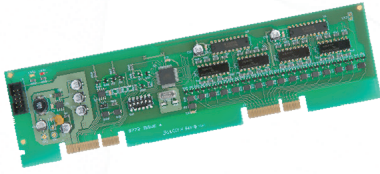

To add more I/O capability to the L@titude control panel

- 16 channels
- Each channel configurable as input or output
- Inputs opto-isolated
- Outputs open collector transistor
- Up to 32 boards supported per panel (including external I/O modules) (512 Input/Output Channels)
- Inputs and outputs configurable as per field devices
- Full cause and effects on all inputs and outputs
- Multi drop RS485 communications
- Can be used with other HFP I/O modules on the same panel

8 Way Relay Extender Module

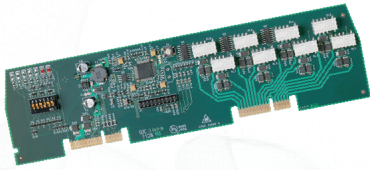

Additional relay output capability can be added using HFP relay boards

- 8 volt free relay contacts (1AMP 30V DC)
- All outputs programmable for cause and effects
- Can be used with other HFP I/O modules on the same panel
- Multi drop RS485 communications

8 Way Conventional Detection Zone Module

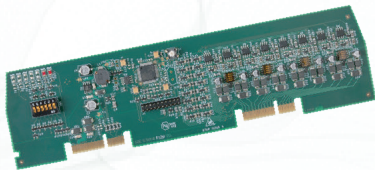

Eight conventional detection circuits can be connected with conventional detector

- 8 monitored detection zone inputs
- Directly replaces a conventional control panel when integrating into an analogue addressable system
- Can be used with other HFP I/O modules on the same panel
- Multi drop RS485 communications

4 Way Sounder Extender Module

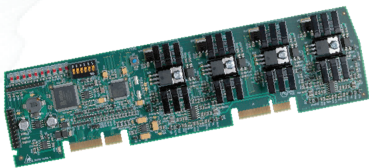

Additional sounder output capability can be added using HFP sounder boards

- 4 individually fused and monitored sounder outputs
- All outputs programmable for cause and effects
- Can be used with other HFP I/O modules on the same panel
- Multi drop RS485 communications

Fault Tolerant Network Module

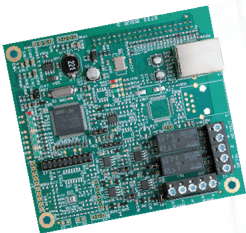

Allows further enhancement by connecting control panels and repeaters using high integrity network

- High integrity protocol
- Fully secure against short or open circuit faults
- Simple 2-wire network connection
- Repeaters share network connection
- Network wide test and disablement functions
- Network wide cause and effect logic
- Flexible configuration options
- Panels configurable to act on network events or not as required

HFP AP-AS (Analogue Addressable 1-2 Loop Control Panels)

The HFP AP-AS is a powerful and versatile Single or Two Loop Analogue Addressable Fire Control Panel. HFP AP-AS supports Hochiki ESP loop drivers, which are all capable of providing up to 400 milliamps of loop current for the most demanding applications.

An integral 3 Amp power supply and temperature compensated battery charger provides ample power for the two, 1 Amp rated standard sounder outputs, loop powered sounders and other devices.

HFP AP-AS is also available as a HFP AP-ASL version offering a very cost effective solution for smaller standalone installations requiring only one detection loop.

The HFP AP-ASL version does not support the following: Second loop, Printer output, Networking and connection of I/O boards or the HFP AP-CRL repeater.



FEATURES

- 16 zonal LED indicators
- 2 programmable sounder circuits
- 3 programmable relays
- 3A power supply
- Large graphic display
- Expandable from 1 to 2 loops*
- Certified to EN54-2 / EN54-4
- Up to 512 additional programmable I/O via HFP I/O modules*
- Stores 500 last events in event log
- Compact, stylish enclosure
- Different language and character set variants available
- Real time clock
- 5 programmable inputs
- Installer friendly, removable equipment chassis
- Sensitivity adjustment and Drift Compensation
- Compatible with HFP and HFP AP-CRL repeaters*
- Fully EN54-2 and EN54-4 compliant improved front loading Printer option* **
- Powerful, network wide cause & effects*

*These items not available on HFP ASL panel. **Can be fitted to M3 size enclosure only

HFP AP CONNECTION Diagram (High Integrity Configurable Connection Guide)

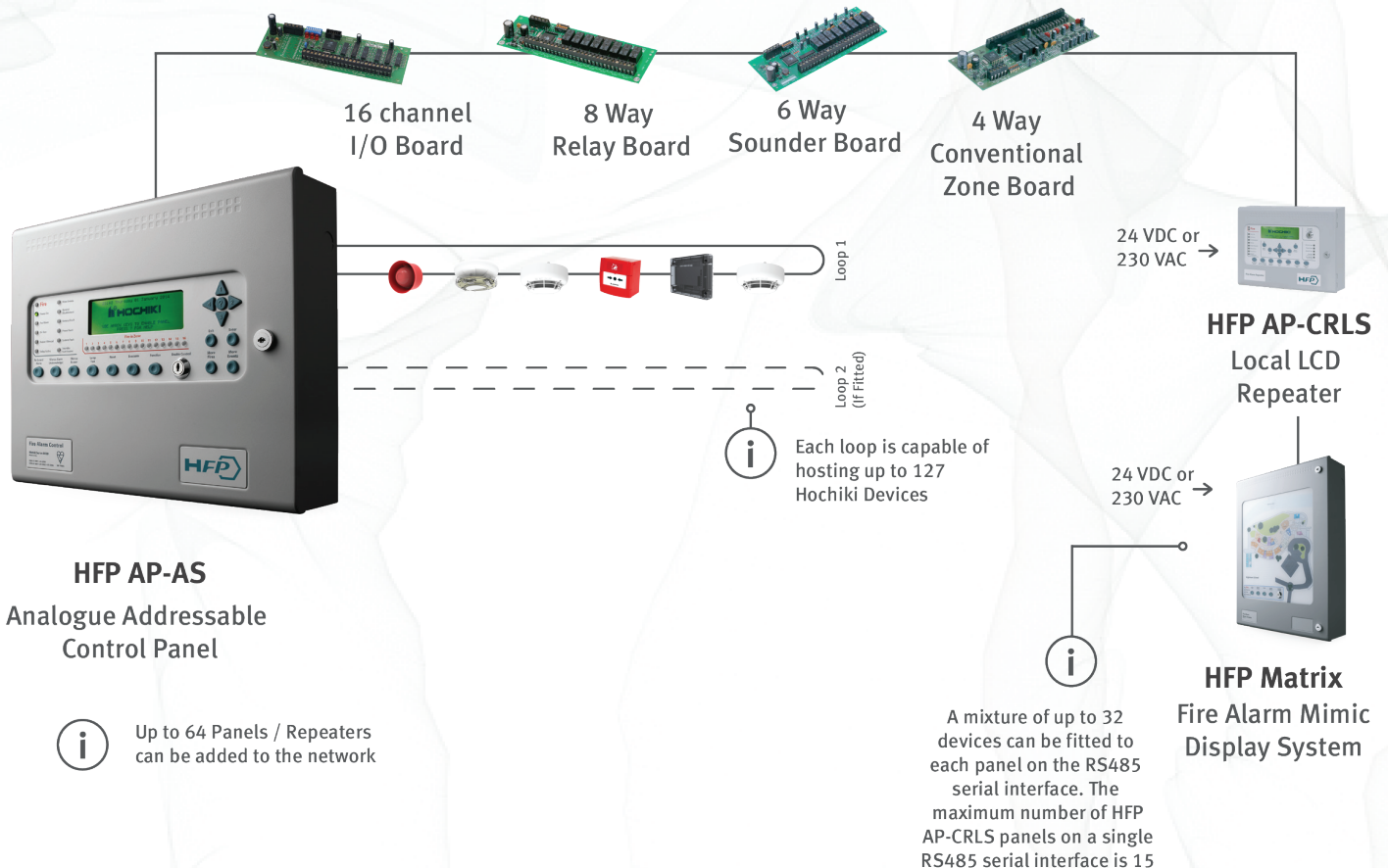

Specifications subject to change without prior notice

K555 Network Card (HFP Networking Card)

The flexibility of the HFP system can be further enhanced by connecting control panels and repeaters together using a high integrity network.

A simple 2-wire connection between each panel allows events to be transmitted to other parts of the system to provide indication or control on a system wide basis. Using the Loop Explorer configuration programme, up to 64 nodes can be programmed to respond in a variety of ways to any system events as required.

This flexibility extends the comprehensive cause and effect programming capability of control panels to the entire network allowing actions, test modes or disablements to be started from any point.

The fault tolerance of the network is such that any single open or short circuits fault will not result in any loss of information. Multiple faults are isolated and the network breaks into smaller networks which continue to work autonomously.

Flexible network configuration options using simple to follow PC configuration program

Two core wiring ensures network integrity by providing full isolation of faulty wiring segments

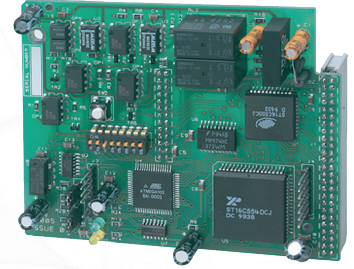

FEATURES

- Up to 64 nodes
- High integrity protocol
- Fully secure against short or open circuit faults
- Simple 2-wire network connection
- Network wide test and disablement functions
- Network wide cause and effect logic
- Flexible configuration options
- Panels configurable to act on network events or not as required
- Multiple panels supported on single network

Repeater (Analogue Addressable Fire Control Panel Repeater)

HFP AP-CRLS

Local LCD Control Repeater

The HFP AP-CRLS fire alarm repeater provides an alternative to HFP AP-PRNS network connected repeaters and provides a cost effective, simple and convenient method of extending the controls and indications of the HFP fire alarm control panel to other locations.

The larger, graphic LCD, brightness LED indicators and full set of controls duplicate the indications and controls on the HFP fire alarm control panel at up to 15 additional locations via a (separate to the HFP network) simple, two wire serial data connection.

Ideal for locations where a control and indication point smaller than a full fire alarm control panel is required, the HFP AP-CRLS is available in either a 24 VDC powered option (which can be powered via an additional 2 cores from the HFP control panel auxiliary 24 VDC supply) or a 230V power option with local battery back up.



PERIPHERALS

HFP AP-CRLS Local LCD Control Repeater

- Semi-Flush Mounting
- Power Supply 750mA
- Access Enable Key-switch

Addressable Fire Detection

Hochiki's comprehensive ESP intelligent (Analogue Addressable range) is suitable for even the most demanding environments and incorporates high performance sensors, a wide selection of input and output modules and ancillaries. All products use Hochiki's high integrity digital communications link "ESP" (Enhanced Systems Protocol) that's at the heart of the ESP range.



ALN-EN

An **Intelligent Photoelectric Smoke Sensor** incorporating Hochiki's unique High Performance Chamber which allows the sensor threshold level to be increased, thereby improving the signal to noise ratio and reducing susceptibility to false alarms.

STANDARD FEATURES

- Removable, High Performance Chamber
- Twin fire LEDs allow 360° viewing
- Locking mechanism (sensor to base)
- Variable sensitivity
- Electronically addressed
- Pulsing/non-pulsing controlled from panel*
- Addressed via TCH-B200 Hand Held Programmer
- Approved by LPCB, VdS

Available with an integrated SCI: **ALN-EN(SCI)**

Available with SIL2 Capable: **ALN-EN/SIL**



ACC-EN

An **Intelligent Multi Sensor** incorporating a thermal element and a High Performance photoelectric smoke chamber. Has three modes controlled from the Control Panel, allowing either the optical or thermal element or both to be active in making the fire decision.

STANDARD FEATURES

- User selectable modes
- Incorporates Optical & Heat elements
- Removable, High Performance Chamber
- Twin fire LEDs allow 360° viewing
- Pulsing/non-pulsing controlled from panel*
- Variable sensitivity
- Electronically addressed
- Addressed via TCH-B200 Hand Held Programmer
- Approved by LPCB, VdS

Available with an integrated SCI: **ACC-EN(SCI)**

Available with SIL2 Capable: **ACC-EN/SIL**



ATJ-EN

An **Intelligent Multi-Heat Sensor** incorporating a variable Fixed Temperature heat element and Rate Of Rise heat element, both controlled from the Control Panel allowing either thermal element or both elements simultaneously to be active in making the fire decision.

STANDARD FEATURES

- User selectable modes
- Incorporates Fixed Temperature and Rate Of Rise Heat elements
- Twin fire LEDs allow 360° viewing
- Pulsing/non-pulsing controlled from panel*
- Electronically addressed
- Addressed via TCH-B200 Hand Held Programmer
- LPCB & VdS approved to Classes A, B & C

Available with an integrated SCI: **ATJ-EN(SCI)**

Available with SIL2 Capable: **ATJ-EN/SIL**

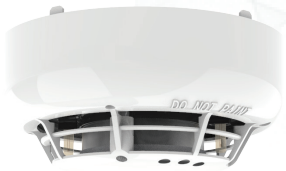

ACD-EN

Addressable Multi Sensor with CO detection, an addressable loop-powered multi-sensor, with smoke, heat and CO sensing elements. The unit offers 24 different modes of operation* and seamlessly matches the other sensors in the ESP range. The CO sensing element can be used to detect smoke as well as life-threatening CO levels (acting as a CO alarm).

STANDARD FEATURES

- User selectable modes
- Low profile
- Twin fire LEDs allow 360° viewing
- Multiple modes
- Heat, Optical and CO sensing elements
- CO Alarm (COHb) facility
- 10 year CO sensor life
- Programmable fire threshold level
- RI & LED controllable separately if required
- 2 colour LED (Polling: Green, Fire: RED)
- Addressed via TCH-B200 Hand Held Programmer

*Please ensure control panel compatibility

ACB-EW



An **Intelligent IP67 Rated Waterproof Multi-Heat Sensor** which can be used externally and is supplied with its own fixing base which is used to fix the sensor. Flying leads from the sensor connect directly to the loop via waterproof connectors.

STANDARD FEATURES

- User selectable modes
- Incorporates Fixed Temperature and Rate Of Rise Heat elements
- Twin fire LEDs allow 360° viewing
- Pulsing/non-pulsing controlled from panel*
- IP67 rated
- Supplied with fixing base
- Electronically addressed via TCH-B200 Hand Held Programmer & PL-2
- LPCB & VdS approved to Classes A, B & C

ESP FIREBEAM XTRA



An **Intelligent Reflective Beam Smoke Detector** fully approved to EN 54-12:2015 which can offer a maximum detection range of 160m. The unit's newly designed optics increase sensitivity whilst the enhanced internal software reduces false alarms.

STANDARD FEATURES

- 7-70m standard detection range
- Extensions kits available to enhance detection range up to 160m
- Approved by VdS to EN 54-12:2015
- Brand new optics design reduces false alarms
- Fully compatible with the Hochiki ESP analogue addressable protocol

YBN-R/3



A **Common Mounting Base** which is fully compatible with Hochiki's ESP range of sensors. Supplied with square cable clamps for secure and reliable cable termination and is also capable of driving a remote LED if required.

(Red version for Sounders available - see below)

STANDARD FEATURES

- Electronics free
- Stainless steel contacts
- Takes 2.5mm² cables
- Slim profile - only 8mm
- Rugged wiring contacts
- Facility for remote indicator
- Quick Connection via square cable clamps
- Sounder version available in either red or white for use with CHQ-WS2 Wall Sounders or CHQ-WSB2 Wall Sounder Beacons - YBO-R/3 and YBO-R/3(WHT)

Available with an integrated SCI: **YBN-R/3(SCI)**

Available with SIL2 Capable & Integral SCI: **YBN-R/3(SCI)/SIL**

YBV-R/4

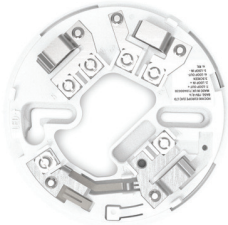

SCI Sensor Mounting Base which is fully compatible with Hochiki's ESP range of SCI sensors. It is supplied with square cable clamps for secure and reliable cable termination and is also capable of driving a remote LED if required.

STANDARD FEATURES

- Electronics free
- Stainless steel contacts
- Takes 2.5mm² cables
- Slim profile - only 8 mm
- Rugged wiring contacts
- Facility for remote indicator
- Quick Connection via square cable clamps
- Fourth terminal enables SCI functionality

CHQ-WS2

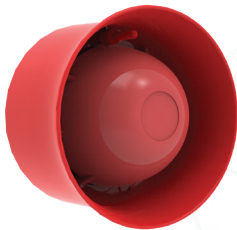

An **Intelligent Loop-Powered Wall Sounder** providing 8 volume levels and 51 tones with a maximum output of up to 102 dB(A)(±2 dB(A)) with low current consumption.

STANDARD FEATURES

- Loop Powered
- Single Loop Address - addressed via the TCH-B200 Hand Held Programmer
- Variable Sound Output 90~102 dB(A) (±2 dB(A)) output at 1 metre
- Weatherproof Kit available
- Auto-shutdown Mode available*
- Approved by LPCB, VdS
- 51 User-Selectable Tones (all tones EN54-3 compatible)

Available with SIL2 Capable: **CHQ-WS2/SIL**

*Please ensure control panel compatibility

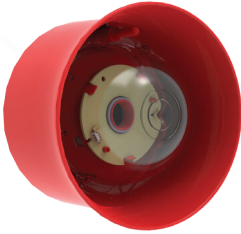

CHQ-WSB2

An **Intelligent Loop-Powered Wall Sounder Beacon** as per the CHQ-WS2 but additionally featuring an integral beacon within the horn which utilises high intensity LED technology.

As per CHQ-WS2(HFP) plus:

STANDARD FEATURES

- Variable flash frequency*¹
- High Intensity LED technology
- Independent control of Sounder and Beacon*¹
- Auto-shutdown Mode available - can be set independently for sounder or beacon*¹
- Approved to EN54-23:2010 - Category 'O'
- Addressed via TCH-B200 Hand Held Programmer

Available with SIL2 Capable: **CHQ-WSB2/SIL**

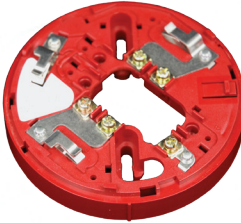

YBO-R/3

A **Sounder Mounting Base** which is fully compatible with Hochiki's ESP range of sensors and designed specifically for the Hochiki range of wall sounders, the CHQ-WS2 Wall Sounder and the CHQ-WSB Wall Sounder Beacon.

It is supplied with square cable clamps for secure and reliable cable termination.

STANDARD FEATURES

- Electronics free
- Stainless steel contacts
- Takes 2.5mm² cables
- Slim profile - only 13 mm
- Rugged wiring contacts
- Quick Connection via square cable clamps
- Also available in white

Available with an integrated SCI: **YBO-R/SCI(RED)**
YBO-R/SCI(WHT-SNDR)

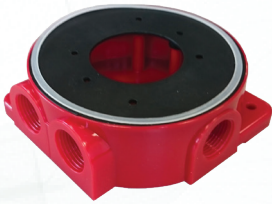

CHQ-WPK

A **Weatherproof Back Box** and gasket set for the CHQ-WS2 Wall Sounder, CHQ-CB Ceiling Beacon, CHQ-WB Wall Beacon and CHQ-WSB2 Wall Sounder Beacon, increases the IP Rating of the Sounder to IP65 for external use.

STANDARD FEATURES

- Easy to install
- Increases sounder IP Rating from IP21 to IP65 (external use)
- Increases beacon IP from IP21 to IP33 (external use)



YBO-BS

An **Intelligent Loop-Powered Base Sounder** providing 13 volume levels and 51 tones with a maximum output of up to 98 dB(A) (±2dB(A)) with low current consumption.

Compatible bases:
YBN-R/3 OR YBN-R/3(SCI) Bases

STANDARD FEATURES

- Loop Powered
- Single Loop Address - addressed automatically by Control Panel or via the TCH-B200 Hand Held Programmer
- 50~98 dB(A) (±2 dB(A)) output at 1m
- Fits Hochiki Standard or Isolator Base and supports ESP Sensors, Beacons and Remote Indicator
- Approved by LPCB, VdS
- 51 User Selectable Tones (all tones EN54-3 compatible)

Available with SIL2 Capable: **YBO-BS/SIL**



YBO-BS2(SCI)

An **Intelligent Loop-Powered Base Sounder** providing 13 volume levels and 51 tones with a maximum output of up to 98 dB(A) (±2 dB(A)) with low current consumption.

Compatible bases:
YBV-R/4 Base

STANDARD FEATURES

- Loop Powered with Single Loop Address - addressed automatically by Control Panel or via the TCH-B200 Hand Held Programmer
- Variable Sound Output 50~98 dB(A) (±2 dB(A)) output at 1m
- Designed for use with YBV-R/4 mounting base
- Incorporates SCI active LED
- Supports ESP SCI Sensors, Addressable Beacons and Addressable Remote Indicator
- 56 User-Selectable Tones (all tones EN54-3 approved)
- Auto-Shutdown feature prevents noise pollution*¹
- Approved by LPCB & VdS

*Please ensure control panel compatibility

YBO-BSB2

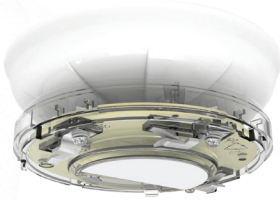

An **Intelligent Loop-Powered Base Sounder Beacon** providing 13 volume levels and 51 tones with a maximum output of up to 98 dB(A)(±2 dB(A)) with low current consumption.

Compatible bases:
YBN-R/3 or YBN-R/3(SCI) Bases

STANDARD FEATURES

- Loop Powered
- Single Loop Address, addressed by either Control Panel or TCH-B200
- 50~98 dB(A)(±2 dB(A)) output at 1m
- Fits Hochiki Standard or Isolator Base and supports ESP Sensors, Beacons and Remote Indicator
- Beacon and Sounder can be controlled independently*1
- Approved to EN54-23:2010 - Category 'O'
- 51 User-Selectable Tones (all tones EN54-3 compatible)

Available with SIL2 Capable: **YBO-BSB2/SIL**

CHQ-CB



An **Intelligent Loop-Powered Ceiling Beacon** with a high-intensity LED and a custom designed free-form optic which produce a highly visible flash. Variants available in 5m, 7.5m, 10m and 15m area coverage.

STANDARD FEATURES

- High Intensity LED technology
- 0.5/1 Hz flash frequency
- Addressable via TCH-B200
- Choice of 2 LED colours (red and white)
- Approved to EN54-23:2010 - Category "C"
- High efficiency
- Selectable light output*1
- Operating Voltage 17-41 VDC

CHQ-WB



An **Intelligent Loop-Powered Wall Beacon** with a high intensity LED and a custom designed free-form optic which produces a highly visible flash. Variants available in 5m, 7.5m and 10m area coverage.

Compatible bases:
YBN-R/3, YBN-R/3(SCI), YBO-BS or the YBO-R/3(SCI)

STANDARD FEATURES

- High Intensity LED technology
- 0.5/1 Hz flash frequency
- Addressable via TCH-B200
- Choice of 2 LED colours (red and white)
- Approved to EN54-23:2010 - Category 'W'
- High efficiency
- Selectable light output*1
- Operating Voltage 17-41 VDC

CHQ-ARI



An **Intelligent Loop-Powered Remote Indicator** with high-intensity LEDs and a Fresnel lens design which produces a highly visible signal. The casing exactly matches the Hochiki ESP Sensor range in shape and colour providing seamless integration.

STANDARD FEATURES

- High Intensity LED technology
- Addressable via TCH-B200
- Approved by VdS
- Non EN54-23 Compliant

CHQ-AB



An **Intelligent Loop-Powered Visual Indicator** with high-intensity LEDs and Fresnel lens design which produces a highly visible flash. The casing exactly matches the Hochiki ESP Sensor range in shape and colour providing seamless integration.

STANDARD FEATURES

- High Intensity LED technology
- 1 Hz flash frequency
- Addressable via TCH-B200
- Choice of 3 lens colours (red, amber and blue)
- Approved by VdS (red and amber lens)
- Non EN54-23 Compliant
- Supplementary indicator

*Please ensure control panel compatibility

Specifications subject to change without prior notice



CHQ-POM

An **Intelligent Powered Output Module** designed to supply a nominal 24 VDC at various, user-selectable current levels from 2 to 32 mA (in increments of 2 mA). The unit is small enough to be added to other third-party devices thereby following a range of equipment to be added to the ESP loop. This unit also features two monitored inputs.

STANDARD FEATURES

- Supplies a nominal 24 VDC at various current levels, 2 mA to 32 mA in increments of 2 mA
- User-selectable current output
- Includes two monitored inputs
- Approved by LPCB & VdS
- Addressed with TCH-B200 Hand Held Programmer & PL-3
- Colour-coded flying leads for simple installation
- Small design, provides simple connectivity to ESP loop for third-party devices, such as IFD-E



CHQ-SIM

An **Intelligent Single Input Module** designed to allow a single monitored input to be connected to the ESP loop. This provides a compact, low-cost option where the installation of the larger CHQ 'Smart-Fix' Range of Modules might be difficult.

STANDARD FEATURES

- Small design for simple provision of a monitored input onto an ESP loop
- Flying leads for easy installation
- Addressed with TCH-B200 Hand Held Programmer & PL-3
- Approved by LPCB & VdS



CHQ-SOM

An **Intelligent Single Output Module** designed to allow a single relay output to be connected to the ESP loop. The unit incorporates a volt-free relay contact that can be configured as either N/O or N/C, the relay contact is rated to 30 VDC (max), 1 A (resistive load). The CHQ-SOM features three colour-coded flying leads, the unit also features a wiring terminal block for loop connection.

STANDARD FEATURES

- Small design for simple provision of a monitored input onto an ESP loop
- Flying leads for easy installation
- Approved by LPCB
- Addressed with TCH-B200 Hand Held Programmer & PL-3

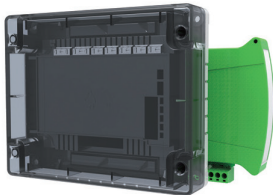

CHQ-MRC2(SCI)

An **Intelligent Mains Relay Controller** providing a single mains rated relay output for the control of such devices as dampers, extractors or plant and equipment shut-down. The monitored input can be used for local power supply fault monitoring or as a general-purpose input. Feature an integral short-circuit isolator.

STANDARD FEATURES

- 1 x mains out & 1 x input
- Integral SCI
- Loop-powered
- Single loop address
- DIL switch addressable
- Single mains rated relay contact
- Relay contact rated at 250 VAC @ 5A (resistive) & 48 VDC @ 2A (resistive)
- Auxiliary monitored input
- Approved by LPCB
- Can be used with CHQ-BACKBOX to comply with BS 7671

Available as a DIN Rail mountable version: **CHQ-MRC2/DIN(SCI)**

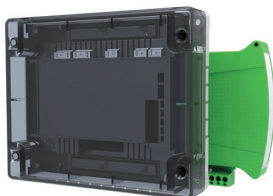

CHQ-DRC2(SCI)

An **Intelligent Dual Relay Controller** designed to provide two general-purpose relay outputs, each output can be controlled independently and used to control dampers, plant and equipment shut-down. The monitored input can be used for local power supply fault monitoring or as a general-purpose input. Feature an integral short-circuit isolator.

STANDARD FEATURES

- Loop powered
- Single loop address
- DIL switch addressable
- Relays contact rated at 30 VDC at 1 A
- Auxiliary monitored input
- Approved by LPCB & VdS
- Deeper back box available (CHQ-BACKBOX)
- Two independently controlled changeover relays
- Can be used with CHQ-BACKBOX to comply with BS 7671

Available as a DIN Rail mountable version: **CHQ-DRC2/DIN(SCI)**

Available with SIL2 Capable & Integral SCI: **CHQ-DRC2(SCI)/SIL**

CHQ-PCM(SCI)



A **Plant Control Module** with four independent change-over relay outputs, with N/O and N/C volt free contacts and four inputs. These outputs can be driven separately by the fire alarm control panel and can be used for the control of devices such as dampers or for plant and equipment shut-down. Feature an integral short-circuit isolator.

STANDARD FEATURES

- 4x inputs & 4x outputs
- Single loop address
- Loop powered
- DIL switch addressable
- 4 change-over relay outputs
- 4 independent inputs for monitoring of volt-free contacts
- Approved by LPCB
- Deeper back box available (CHQ-BACKBOX)
- Can be used with CHQ-BACKBOX to comply with BS 7671

Available as a DIN Rail mountable version: **CHQ-PCM/DIN(SCI)**

Available with SIL2 Capable & Integral SCI: **CHQ-PCM(SCI)/SIL**

CHQ-DIM2(SCI)



An **Intelligent Dual Input Module** designed to interface to a variety of inputs such as door contacts, sprinkler flow/door switches and plant equipment. Feature an integral short-circuit isolator.

STANDARD FEATURES

- Loop powered
- Single loop address
- DIL switch addressable
- Each input can be configured to operate on either an open or short-circuit
- Approved by LPCB & VdS
- Can be used with CHQ-BACKBOX to comply with BS 7671

Available as a DIN Rail mountable version: **CHQ-DIM2/DIN(SCI)**

Available with SIL2 Capable & Integral SCI: **CHQ-DIM2(SCI)/SIL**

CHQ-DZM(SCI)



An **Intelligent Dual Zone Module** designed to allow up to 60 conventional detectors (30 per zone) or up to 6 SPC-ET (3 per zone) to be interfaced to Hochiki's ESP analogue addressable system. The unit also features Schottky and Zener line continuity options. Feature an integral short-circuit isolator.

STANDARD FEATURES

- 2 x zonal inputs
- Single loop address
- Supports two independent zones of conventional detectors
- DIL switch addressable
- Requires an auxiliary 24 VDC supply
- Approved by LPCB
- Deeper back box available (CHQ-BACKBOX)
- Both zones fully monitored for open and short circuit
- Can be used with CHQ-BACKBOX to comply with BS 7671

Available as a DIN Rail mountable version: **CHQ-DZM/DIN(SCI)**

Available with SIL2 Capable & Integral SCI: **CHQ-DZM(SCI)/SIL**

CHQ-SZM2(SCI)

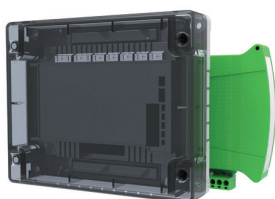

An **Intelligent Single Zone Monitor** designed to allow up to 6 conventional detectors or 1 SPC-ET to be interfaced to Hochiki's ESP analogue addressable system. Feature an integral short-circuit isolator.

STANDARD FEATURES

- 1 x zonal input
- Loop powered
- Up to 6 Conventional Detectors
- DIL switch addressable
- Single loop address
- Remote LED output
- Approved by LPCB & VdS
- Deeper back box available CHQ-BOX
- Fully monitored for open and short circuits faults
- Can be used with CHQ-BACKBOX to comply with BS 7671

Available as a DIN Rail mountable version: **CHQ-SZM2/DIN(SCI)**

CHQ-DSC2(SCI)



An **Intelligent Dual Sounder Controller** which has been designed to provide two sounders outputs (that can be driven separately) with full fault monitoring. The monitored input can be used for local power supply fault monitoring or as a general-purpose input. Feature an integral short-circuit isolator.

STANDARD FEATURES

- Single loop address
- Two independent sounder circuits
- DIL switch addressable
- Each circuit fully monitored for Open and Short Circuit faults
- Each alarm circuit fused at 1 A
- Auxiliary monitored input
- Outputs are synchronised and can be driven continuously or intermittently
- 24 VDC auxiliary power required
- Approved by LPCB & VdS
- Can be used with CHQ-BACKBOX to comply with BS 7671

Available as a DIN Rail mountable version: **CHQ-DSC2/DIN(SCI)**

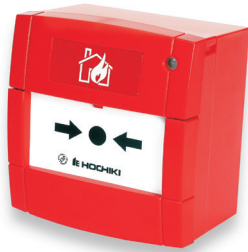

HCP-E(SCI)

An **Intelligent Manual Call Point** fully compatible with Hochiki's ESP analogue addressable protocol and featuring an integral short-circuit isolator (SCI). Features a bi-coloured LED to indicate either fire (red) or short-circuit (amber). Also features plug-in wiring terminals for easy installation.

STANDARD FEATURES

- Fast response
- Integral short-circuit isolator
- Bi-colour status LED
- Non-frangible element fitted as standard (conforms to EN54)
- Addressed with TCH-B200 Hand Held Programmer & PL-3
- Surface or flush mounting
- LPCB Approved to EN54

Available with SIL2 Capable & Integral SCI: **HCP-E(SCI)/SIL**



HCP-W(SCI)

An **Intelligent IP67 Weatherproof Manual Call Point** fully compatible with Hochiki's ESP analogue addressable protocol and featuring an integral short-circuit isolator (SCI). Features a bi-coloured LED to indicate either fire (red) or short-circuit (amber). Also features plug-in wiring terminals for easy installation.

STANDARD FEATURES

- Fast response
- Integral short-circuit isolator
- Bi-colour status LED
- Non-frangible element fitted as standard (conforms to EN54)
- Surface mounting
- LPCB Approved to EN54
- IP67 rated

Available with SIL2 Capable & Integral SCI: **HCP-W/SCI/SIL**

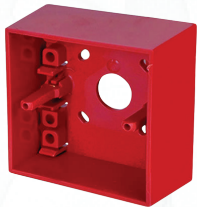

SR BACKBOX

Call Point Surface Mounting Box for HCP-E(SCI). Allows addressable call point HCP-E(SCI) to be surface mounted.

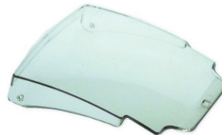

PS200

Hinged cover for Call Point, an acrylic hinged cover for the HCP-E(SCI) manual call point range which protects against accidental operation/vandalism.

STANDARD FEATURES

- Easy to install
- Protects against accidental activation
- Requirement under BS5839

Conventional Fire Detection

Hochiki's CDX range offers one of the most extensive product portfolios available, providing solutions for most conventional fire detection applications as well as security systems, due to its wide operating voltage range (9.5~30 VDC).



SOC-E3N

A **Conventional Photoelectric Smoke Detector** which is fully compatible with the majority of existing Conventional systems.

STANDARD FEATURES

- Removable, High Performance Chamber
- Automatic Sensitivity Window Verification (ASWV) - Drift Compensation Technology
- Remote Indicator Output
- Wide voltage range (12 ~ 30 VDC)
- Low profile design with one piece outer cover
- Single fire LED - 360° viewing
- Range of mounting bases
- Approved by LPCB



DCD-AE3

A **Conventional Rate of Rise Heat Detector** incorporating a 60°C fixed temperature element. The thermistor and linearising circuit provide an accurate linear response Heat Detector. A third terminal provides integral remote indicator output.

STANDARD FEATURES

- Electronic linear heat detection
- Remote Indicator output
- Wide voltage range (9.5 ~ 30 VDC)
- Twin fire LEDs allow 360° viewing
- Range of mounting bases
- Approved by LPCB & VdS



DCD-CE3

A **Conventional Rate of Rise Heat Detector**, Rate of Rise with 90°C temperature element. The thermistor and linearising circuit provide an accurate linear response Heat Detector. A third terminal provides integral remote indicator output.

STANDARD FEATURES

- Electronic linear heat detection
- Remote Indicator output
- Wide voltage range (9.5 ~ 30 VDC)
- Twin fire LEDs allow 360° viewing
- Full range of mounting bases
- Approved by LPCB & VdS



DFJ-AE3

A **Conventional 60°C Fixed Temperature Heat Detector** using a thermistor and linearising circuit to provide an accurate linear response Heat Detector. A third terminal provides integral remote indicator output.

STANDARD FEATURES

- Electronic linear heat detection
- Remote Indicator output
- Wide voltage range (9.5 ~ 30 VDC)
- Twin fire LEDs allow 360° viewing
- Fixed Temperature Detector
- Full range of mounting bases
- Approved by LPCB & VdS



DFJ-CE3

A **Conventional 90°C Fixed Temperature Heat Detector** using a thermistor and linearising circuit to provide an accurate linear response. A third terminal provides integral remote indicator output.

STANDARD FEATURES

- Electronic linear heat detection
- Wide voltage range - can be installed on security systems
- Twin fire LEDs allow 360° viewing
- Fixed Temperature Detector
- Full range of mounting bases
- Approved by LPCB & VdS



DFG-60BLKJ

An **IP67 Waterproof Conventional 60°C Fixed Temperature Heat Detector** with minimal standby current and high reliability. Particularly suited to environments, which are exposed to high levels of condensation or are hosed down.

STANDARD FEATURES

- Waterproof design - rated to IP67
- Low profile shape
- Utilises a bi-metallic strip to sense temperature change
- No Mounting base required
- Minimal standby current
- Approved by LPCB & VdS



DRD-E

A **Conventional Flame Detector** designed for internal use to detect large flames. The detector fits any of the CDX range of mounting bases. The detection zone is a 90° cone and the detection range is up to and including 25m.

STANDARD FEATURES

- Class 1 performance as defined in BS EN54-10:2002 (range up to 25m)
- Single IR technology
- Robust and slim design
- Low current consumption
- Easy to install
- Fits any of the CDX Range of mounting bases
- Twin LEDs for 360° view
- Approved by LPCB & VdS



IFD-E

A **Conventional IR³ Infrared Flame Detector** designed to respond to low-frequency (1 to 15Hz) flickering IR radiation emitted from flames during combustion, the unit can discriminate between flames and spurious sources of radiation such as sunlight. An I.S. version and an explosion-proof version are also available.

STANDARD FEATURES

- Triple IR sensor
- Class 1 sensitivity to EN54-10 detects 0.1m² fire @ 25m
- Excellent optical interference immunity (solar blind)
- Selectable output options - conventional 2-wire, 4-20 mA, latching or non-latching relay contacts, fire/fault, pre-alarm
- Selectable response speed
- Optical self-test
- Low power consumption
- Approved by LPCB
- SIL Capable



16591

A **UV/Dual IR Flame Detector, Alloy Housing, Model 16591** is an IR² flame detector with an additional UV detection element, designed for use where open flaming fires may be expected and responds to the light emitted from flames during combustion.

The detector discriminates between flames and other light sources by responding only to particular optical wavelengths and flame flicker frequencies. This enables the detector to avoid false alarms due to such factors as flickering sunlight.

STANDARD FEATURES

- Highest immunity to false sources
- Suitable for indoor and outdoor areas
- Detects invisible flames from fuels such as Hydrogen and other inorganic fuels
- Selectable response speed
- Optical self-test
- Low power consumption
- Approved to EN54



YBN-R SERIES

Conventional Detector Mounting Bases associated with the CDX Range of Detectors and Beacons and is fully compatible with the majority of existing conventional fire alarm control panels.

STANDARD FEATURES

- Integral remote indicator output
- Low Profile, only 8mm
- Quick connections via square clamps
- Accepts up to 2.5mm² cables
- Bayonet slot, low insertion force for detectors

Conventional Detector Mounting Base: **YBN-R/6**

Conventional Detector Mounting Base with in-line Schottky Diode: **YBN-R/6SK**

YBO-R SERIES



Mounting Bases associated with the CDX Range of Detectors and is fully compatible with the majority of existing conventional fire alarm and security control panels.

STANDARD FEATURES

- Integral remote indicator output
- Rugged design
- Quick connection via square cable clamps
- Accepts up to 2.5mm² cables
- Bayonet slot, low insertion force for detectors

Conventional Detector Mounting Base: **YBO-R/6PA**

Conventional Latching Relay Detector Mounting Base: **YBO-R/6R**

Conventional Non-Latching Relay Detector Mounting Base: **YBO-R/6RN**

Conventional Latching Schottky Diode Relay Detector Mounting Base: **YBO-R/6RS**

CSB-E

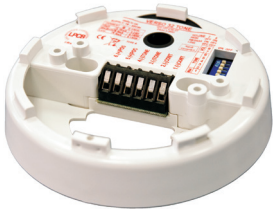

A **Conventional Base Sounder** which has been designed to complement the CDX range of detectors. Improved electronic design enables very low current consumption whilst providing a range of tones and volumes selectable from each unit.

STANDARD FEATURES

- Robust design
- Low current consumption
- Easy to install
- Maximum 93 dB(A) @ 1m (Tone 1)
- 32 user-selectable tones and 3 user-selectable volumes
- Lockable cap available (CS/CAP)

CSBB-E



A **Conventional Base Sounder Beacon** which has been designed to complement the CDX range of detectors. Improved electronic design enables very low current consumption whilst providing a range of tones and volumes selectable from each unit. Features integral beacon.

STANDARD FEATURES

- Robust design
- Low current consumption
- Easy to install
- Maximum 93 dB(A) @1m (Tone 1)
- 32 user-selectable tones and 3 user-selectable volumes
- Utilises high intensity LEDs
- Lockable cap available (CS/CAP)
- Supplementary indicator
- Non EN54-23 compliant

CWSB-E



A **Conventional Wall Sounder Beacon** with improved electronic design enables very low current consumption whilst providing a very low range of tones and volumes selectable from each unit. Features integral beacon.

STANDARD FEATURES

- Robust design
- Low current consumption
- Easy to install
- Maximum 113 dB(A) @ 1m (Tone 15)
- 32 user-selectable tones
- Utilises high intensity LEDs
- Supplementary indicator
- Non EN54-23 compliant

CLB-E



A **Conventional Visual Indicator** for use on 24 V Sounder Circuits. The unit is fitted with a Fresnel lens and high-intensity LEDs, a design which produces a highly visible flash. The casing exactly matches the CDX Detector range in shape and colour providing seamless integration.

STANDARD FEATURES

- High Intensity LED technology
- Fits standard CDX base (YBN-R/6)
- Supplementary indicator
- Not EN54-23 compliant
- Colour-matched to existing detector and base ranges

CWST-S5



A **Conventional Beacon** which features high output LEDs, advanced optics and an innovative lens design, providing outstanding Omni-directional light coverage at low current draw. Specifically designed for, and approved to meet EN54-23. CWST-S5 delivers quality, reliability and long operational life.

STANDARD FEATURES

- Approved to EN54-23, C & W categories*
- Advanced optics ensures superior light coverage at low current draw
- Available in either red or white casings
- Available with either a red or white LED
- Synchronised flash exceeds EN54-23 standard
- Soft start feature reduces power surges during system start-up



CWST-W5

A **Conventional Weatherproof Beacon** which features high output LEDs, advanced optics and an innovative lens design, providing outstanding Omni-directional light coverage at low current draw. Specifically designed for, and approved to meet EN54-23. Weatherproof base provides IP65 for external use applications.

STANDARD FEATURES

- Approved to EN54-23, C & W categories*
- Available in either red or white casings
- Available with either a red or white LED
- Synchronised flash exceeds EN54-23 standard
- Soft start feature reduces power surges during system start-up
- Advanced optics ensures superior light coverage at low current draw



CLAMBELL

A **Conventional Fire Alarm Bell**, EN54-3 approved fire bell incorporates traditional and innovative design. Low power consumption and good sonorous tone result from use of an aluminium gong which also significantly reduces weight.

Three mounting versions are available: shallow base, deep base & purpose designed and weather-proof option.

STANDARD FEATURES

- Tested and Approved by LPCB
- Permanently fitted gong
- Specifically designed weatherproof back box
- Mounting options for European, Asian and US style installations
- Hinged design for quick and easy installation



CCP-E

A **Conventional Manual Call Point** based upon the industry standard KAC world series housing. The unit can support either a 'Frangible Glass' element or a 'Non Frangible Plastic' element. It is also supplied complete with SR-BACKBOX for surface mounting.

Note - Yellow version not EN54 compliant

STANDARD FEATURES

- Approved to EN54-11: 2001
- Other colours available on request
- Approved by LPCB
- Terminals can accommodate up to 2.5mm² solid conductor



CCP-W

An **IP67 Conventional Weatherproof Call Point** which can be used externally.

STANDARD FEATURES

- Approved to EN54-11:2001
- Supplied with back-box as standard
- Other colours available on request
- Ingress Protection rated to IP67
- Approved by LPCB
- Terminals can accommodate up to a 2.5mm² solid conductor



CCP-SAVWIRE

Conventional Sawwire Call Point Red based upon the industry standard KAC world series housing and features easy to install, push-fit wiring terminals. The unit has been specifically designed for use on "Sawwire" (two-wire) systems.

The unit can support either a 'Frangible Glass' element or a 'Non Frangible Plastic' element.

STANDARD FEATURES

- Approved to EN54-11:2001
- Terminals can accommodate up to a 2.5mm² solid conductor
- Designed for use on "Sawwire" (two-wire) systems*



CCP-KS

Conventional Key Switch Manual Call Point based upon the industry standard KAC 9000 series housing and features flying leads for simple wiring.

The unit features two key positions marked as "1" and "0" - with the key easily removable in either position.

STANDARD FEATURES

- Two position keyswitch (marked 1 and 0)
- Key removable in both positions
- Supplied with back box for surface fixing
- Terminals can accommodate up to a 2.5mm² solid conductor
- Supplied in RED - other colours available on request
- Suitable for fire, security and other specialist applications

*Please ensure control panel compatibility

SPECIAL APPLICATION PRODUCTS

Intrinsically Safe

Hochiki's Intrinsically Safe and Explosion Proof range of products have been designed and produced to ensure that all the great benefits of Hochiki's high quality fire detection technology can be safely operated within industrial and hazardous environments. Hochiki's Intrinsically Safe detectors and hazardous area products have been certified by BASEEFA to IECEx and ATEX.

SOC-E-IS



A **Photoelectric Smoke Detector** designed for use in hazardous areas which also incorporates a remote indicator output and a removable chamber for easy maintenance.

STANDARD FEATURES

- Single fire LED - 360° viewing
- Removable, High Performance chamber
- Supported by a range of barriers
- Remote indicator output
- ATEX Classification to: Ex ia IIC T5 Ga (-20°C ≤ Ta ≤ +55°C)
- Suitable for installation in areas at Category 1 (inc all lower categories)
- Available in white and ivory
- Approved by LPCB & VdS
- SIL Level 2 capable

DCD-1E-IS



A **Conventional I.S. Rate of Rise Heat Detector** designed for use in hazardous areas. Incorporates a remote indicator output and a 60°C fixed temperature element.

STANDARD FEATURES

- Twin fire LEDs allow 360° viewing
- Electronics free mounting base
- Remote indicator output
- ATEX certification to: II 1 G Ex ia IIC T5 (-20°C ≤ Ta ≤ +55°C)
- Suitable for installation in areas at Category 1 (inc all lower categories)
- Approved by LPCB, GL and to IECEx
- Also available in White - DCD-1E-IS(WHT)

YBN-R/4(IS)



A **Conventional Detector Mounting Base** associated with the CDX Range of Intrinsically Safe Detectors and is fully compatible with the majority of existing conventional fire alarm control panels.

STANDARD FEATURES

- Low Profile, only 8mm
- Rugged design
- Dedicated cable screen terminal
- Accepts from 1 to 2.5mm² cables
- Quick connection via square cable clamps
- Electronics free
- GL Type approval
- Also available in White - YBN-R/4IS(WHT)

CCP-E-IS



A **Conventional Manual Call Point** designed for use in hazardous areas and based upon the industry standard KAC world series housing.

STANDARD FEATURES

- Supports either a 'Frangible Glass' element or a 'Non Frangible Plastic' element
- Terminals can accommodate up to a 2.5mm² solid conductor
- Approved to EN54 Part 12
- Rugged design
- GL Type approval
- ATEX Classification to: II 1G Ex ia IIC T4 Ga Ta = -10°C to +55°C

CCP-W-IS



A **Conventional Weatherproof Call Point** designed for use in hazardous areas and based upon the industry standard KAC world series housing.

STANDARD FEATURES

- Sealed to IP67
- Supports either a 'Frangible' glass element or a 'Non Frangible' plastic element
- Terminals can accommodate up to a 2.5mm² solid conductor
- Approved to EN54 Part 12
- Rugged design, with anti-tamper facility
- ATEX Classification to: II 1G Ex ia IIC T4 Ga Ta = -10°C to +55°C



IFD-E(IS)

An **Intrinsically Safe Conventional Infrared Flame Detector** designed to respond to low-frequency (1 to 15Hz) flickering IR radiation emitted from flames during combustion, the unit can discriminate between flames and spurious sources of radiation such as sunlight.

STANDARD FEATURES

- Unaffected by convection currents, draughts or wind and solar-blind
- Tolerant of fumes, vapours, dust and mist
- ATEX certification to: II 1G Ex ia IIC T4 Ga (135°C) (zones 0,1 and 2)
- Responsive to a flame more than 25m away
- Selectable response speed
- Class 1 performance as defined in BS EN54-10:2002 (on the high sensitivity setting)
- Approved by LPCB
- SIL capable
- Mounting bracket available IFD-MB



IFD-E(EXD)

A **Conventional Explosion-Proof Infrared Flame Detector** designed to respond to low-frequency (1 to 15Hz) flickering IR radiation emitted from flames during combustion, the unit can discriminate between flames and spurious sources of radiation such as sunlight.

STANDARD FEATURES

- Unaffected by convection currents, draughts or wind and solar-blind
- Tolerant of fumes, vapours, dust and mist
- ATEX certificated to: Ex II 2GD Ex d IIC T4 Gb (zones 0, 1, 2)
- Responsive to a flame more than 25m away
- Selectable response speed
- Class 1 performance as defined in BS EN54-10:2002 (on the high sensitivity setting)
- Approved by LPCB
- SIL capable
- Mounting bracket available IFD-MB



CHQ-DZM(SCI)-IS

A **Dual Zone Module** which is fully compatible with Hochiki's ESP analogue addressable protocol and I.S. equipment. The module will allow connection of up to 40 Hochiki I.S. conventional detectors (20 per zone) through a Galvanic isolator or Zener barrier, which are then fully monitored for open and short circuit. Also available as a DIN Rail mountable version. Both models feature an integral short-circuit isolator.

STANDARD FEATURES

- Single loop address
- Supports two independent zones of Hochiki I.S. Conventional Detectors
- Both zones fully monitored for short/open-circuit
- Requires an auxiliary 24 VDC supply
- Both models feature an intergral short-circuit isolator
- Both models approved by LPCB
- Installed in safe area
- Can be used with CHQ-BACKBOX to comply with BS 7671

Available as a DIN Rail & Integral SCI version: **CHQ-DZM/DIN(SCI)-IS**



CHQ-ISM

This **Intrinsically Safe Sounder Interface Module** interfaces between the Hochiki Analogue system via a CHQ-DSC2 or conventional sounder O/P's and the intrinsically safe sounder/beacon units via an intrinsically safe barrier. The module provides line monitoring for open or short circuits on the wiring connected to both the safe and hazardous areas.

STANDARD FEATURES

- Provides dual sounder circuits
- Provides fault-monitored input
- Fully monitored for short-circuits
- Requires 24 VDC external power supply
- Also available as a DIN module
- Installed in safe area only
- Requires I.S. barrier
- Interfaces between loop and I.S. sounders/beacons
- Allows 1 I.S. Sounder or Beacon to be connected per channel
- Can be used with CHQ-BACKBOX to comply with BS 7671

ZENER-DIODE BARRIERS

A **Zener-Diode Barrier, DC version, positive polarity, working voltage 26.5 V at 10 µA series resistance max 327 Ω fuse rating 50 mA, DIN rail mounting.**

STANDARD FEATURES

- Simple installation onto standard DIN 'top-hat' railing

Zener-Diode Barrier Dual Channel: **Z787**

Zener-Diode Barrier 1-Channel: **Z728**

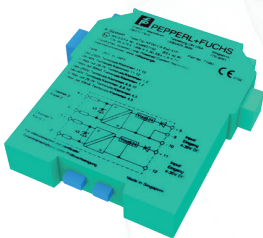

KFDO-CS-EX1.51P

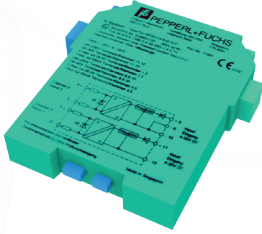

This **Isolated Barrier** is used for intrinsic safety applications. The device transfers DC signals of fire alarms and smoke alarms from the hazardous area to the non-hazardous area. The device can also be used to control I/P converters, valves, indicators, and audible alarms.

STANDARD FEATURES

- 1-channel isolated barrier
- 24 V DC supply (loop powered)
- Current input/output 0 mA ... 40 mA
- I/P or transmitter power supply
- Accuracy 1 %
- Reverse polarity protection

KFDO-CS-EX2.51P

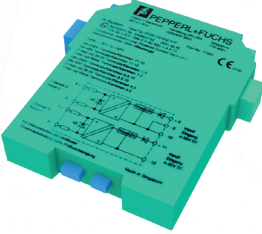

This **Isolated Barrier** is used for intrinsic safety applications. It transfers DC signals from fire alarms, smoke alarms, and temperature sensors in hazardous areas. It can also be used to control I/P converters, power solenoids, LEDs, and audible alarms.

STANDARD FEATURES

- 24 VDC supply
- 2-channel isolated barrier
- Current input/output 0 mA to 40 mA
- I/P or transmitter power supply
- Accuracy 1%
- Reverse polarity protection
- SIL capable

FIRELINK (HIGH SENSITIVITY SMOKE DETECTION)

Hochiki's FIRElink range of high sensitivity air sampling equipment consists of detectors and sampling pipe accessories to the very highest levels of sensitivity in environments such as computer areas and clean rooms. In these applications, it is able to give warning to the very slightest trace of smoke. All detectors in the FIRElink range have been approved to EN54-20:2006 Classes A, B & C by LPCB.

FIRELINK-25



A **Single Pipe Air Sampling Detector** designed to provide very high sensitivity smoke detection. The unit will automatically setup for easy installation and is also designed to fit into a Docking Station which accepts all sampling pipes and cables leaving the detector to be fitted during the final commissioning phase.

STANDARD FEATURES

- Approved LPCB
- False alarms reduced by unique dust discrimination
- RS485 communications for networking and remote communications
- Ultra small, low cost aspirating smoke detector
- Single sampling pipe up to 50m in length (still air)
- High sensitivity provided by laser based forward light scatter for reliable early warning

FIRELINK-100



A **Two Pipe Air Sampling Detector** designed to provide very high sensitivity smoke detection. The unit will automatically setup for easy installation and is also designed to fit into a Docking Station which accepts all sampling pipes and cables leaving the detector to be fitted during the final commissioning phase.

STANDARD FEATURES

- Approved LPCB
- Two sampling pipes up to 100m (aggregate) in length (still air)
- RS485 communications for networking and remote communications
- Ultra small, low cost aspirating smoke detector
- False alarms reduced by unique dust discrimination
- High sensitivity provided by laser based forward light scatter for reliable early warning

FIRELINK-400



A **Four Pipe Air Sampling Detector** designed to provide very high sensitivity smoke detection with inherent immunity to dust/dirt build-up. Discriminates between 'dirty' and 'clean' operating periods such as day and night, automatically substituting appropriate system sensitivity without the need for external input or adjustment.

STANDARD FEATURES

- Approved LPCB
- Four sampling pipes up to 200m (aggregate) in length (still air)
- RS485 communications for networking and remote communications
- False alarms reduced by unique dust discrimination
- High sensitivity provided by laser based forward light scatter for reliable early warning

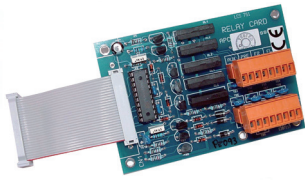

FL-RC

An **Input Relay Card** designed to provide detector inputs that may be programmed for Remote Day/Night Mode Changeover, Remote Reset or ClassiFire Override as well as power supply fault monitoring.

STANDARD FEATURES

- Relay contacts rated at 0.4 A @ 24 VDC
- Common Fault relay energised normally closed for fail safe operation
- Only compatible with FIRElink-25 and FIRElink-100
- 4 staged normally open relay outputs for unmonitored connection to other systems

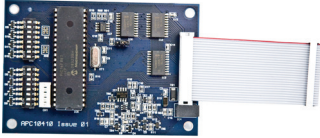

FL-APIC

An **Addressable Protocol Interface Card** used to decode and relay FIRElink detector information directly to an Hochiki ESP compliant Fire Control Panel.

STANDARD FEATURES

- Full address range (1 - 127)
- Compatible with all FIRElink detectors and command modules
- Supports both single and multi mode operation



FIRELINK SAMPLING PIPES

The **Sampling Pipe and Connectors** are used in conjunction with the FIRElink Range of Air Sampling Detectors. The Pipe-cad software supplied with each FIRElink detector calculates the length of pipe and configuration of sampling holes required for each installation.

Prices and further details provided upon request.



FIRELINK DUST FILTERS

FL-DF1, Hochiki Dust Filter FIRElink 400 Series. **FL-DF2**, Hochiki Dust Filter FIRElink 25/100 Series.

Prices and further details provided upon request.

LEAKALARM (WATER LEAK DETECTION SYSTEM)



CHQ-ARI

CHQ-ARI is a loop-powered Addressable Remote Indicator, with high-intensity LEDs and a Fresnel lens design that produces a highly visible signal.

STANDARD FEATURES

- High Intensity LED technology
- Addressable via Hand Held Programmer (TCH-B200)
- Up to 127 devices per loop
- Approved by VdS
- Loop-driven visual indication of a water leak
- Interfaced with the addressable loop



HSVS

This **Voice Enhanced Sounder** delivers a pre-recorded message alert tailored to the LEAKalarm water leak detection system. This unit is easy to install and provides very early warning of leak detection via the LEAKalarm control panel.

STANDARD FEATURES

- Delivers high quality pre-recorded voice alarm message when activated by a water leak
- Easy to install
- Available in multiple languages and message configurations

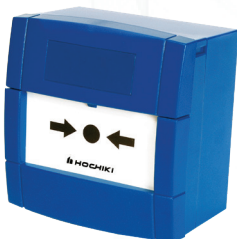

MANUAL CALL POINT WITH SCI

A **Manual call point** designed for use with the LEAKalarm water leak detection system. Activation of the unit results in a water leak alarm being generated at the control panel.

STANDARD FEATURES

- Fast response
- Terminals can accommodate up to a 2.5mm² solid conductor
- Integral short-circuit isolator
- Non-frangible element fitted as standard
- Surface mounting
- LPCB Approved to EN54

SY-BF01
SY-BS01

CHQ-MRC2(SCI)

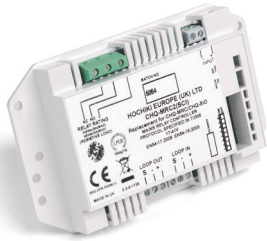

CHQ-MRC2(SCI) is a Single Input/Output Module, which provides a single, mains-rated relay output for the control of such as water shut down valves when used in a LEAKalarm water leak detection system installation.

STANDARD FEATURES

- Loop powered, with single loop address
- Single mains rated relay contact
- Relay Contact Rated at 250 VAC @ 5 A (resistive) & 48 VDC @ 2 A (resistive)
- Auxiliary monitored input
- DIN rail version available
- Both models feature an integral short-circuit isolator

LA-WLDM



Our highly versatile **leak detection module** will support up to 50m of LEAKalarm water leak detection cable or one LEAKalarm water detection Probes per circuit, with two circuits available per device.

STANDARD FEATURES

- Allows connection of water leak detection cable or water leak detection probes
- Connects directly to the loop of the addressable LEAKalarm control panel
- Integral Short Circuit Isolator
- Blue alarm LED per detection circuit

LAAP-S-1



Single and dual loop **LEAKalarm control panels** are available with each loop supporting a maximum of 127 addressable devices.

STANDARD FEATURES

- Both single and dual loop control panels available
- A single loop panel can support up to 254 LEAKalarm Probes, or over 12,000m of water leak detection cable
- A dual loop panel can support in excess of 500 LEAKalarm Probes and over 25,000m of water leak detection cable
- Control panel configuration allows each addressable device to be uniquely identified
- Remote outputs fully configurable
- RS485 panel expansion bus supporting up to 32 additional accessories
- Cause and Effect output control via Loop Explorer 2 PC software
- Fully monitored sounder circuits
- Additional 8-Way relay board also available
- Battery Standby

LA-WLDP



Probes are connected to LEAKalarm Detection Modules (maximum of two per modules) which in turn are connected to the loop of the LEAKalarm water detection system control panel.

STANDARD FEATURES

- Highly responsive water leak detection probe
- Mechanically Robust
- Ideal for refrigeration drip trays and floor voids
- Height adjustable clip option

LAW-05/LAW-10



Linear leak detection is achieved through the installation of this very responsive **sensing cable**, designed to be fixed under false floors, in ceiling voids and other enclosed spaces. Available in lengths of 5m and 10m, the cables can be connected by the locking plug and socket system to cover large areas.

STANDARD FEATURES

- Available in 5 and 10 metre lengths (other lengths on request)
- Simple connection and termination
- Consistent sensitivity
- Aesthetically attractive

MARINE APPROVED (ADDRESSABLE)

Hochiki's Marine Approved Analogue Addressable range of products has been designed around the existing world-proven ESP range and all products utilise the Hochiki ESP Protocol.

MARINE ASM (Marine & Offshore Analogue Addressable 1-2 Loop Control Panel)

Based upon the popular HFP single and two loop analogue addressable fire control panel, the MARINE-ASM is certified with a host of classification societies and is Marine Equipment Directive approved.

MARINE-ASM provides a cost effective and scalable solution for all marine fire alarm systems. Up to 64 MARINE-ASM control panels may be networked to provide integrated control and indication of over 16,000 fire alarm points.

The Voyage Data Recorder interface outputs standard NMEA 0183 protocol and can be fitted inside any control panel on the network.



Suitable for all small to medium sized vessels, MARINE-ASM control panels can be expanded and networked to become part of much larger network. With its large graphical display and ergonomic buttons and indicator layout, the MARINE-ASM control panel is simple and straight forward to understand for installers, commissioning engineers and end user alike.

FEATURES

- 16 zonal LED indicators
- 2 programmable sounder circuits
- 5 programmable inputs
- 3 programmable relays
- 3A power supply
- Large graphic display
- Real time clock
- Powerful, network wide cause and effects
- Hochiki protocol
- Sensitivity adjustment and Drift Compensation
- Same look and feel as HFP range
- Stores 500 last events in event log
- Compact, stylish enclosure
- Installer friendly, removable equipment chassis
- Fully EN54-2 and EN54-4 compliant
- Different language and character set variants available



ALN-ENM

An **Intelligent Photoelectric Smoke Sensor** incorporating Hochiki's unique High Performance Chamber which allows the sensor threshold level to be increased, thereby improving the signal to noise ratio and reducing susceptibility to false alarms.

STANDARD FEATURES

- Removable, High Performance Chamber
- Twin fire LEDs allow 360° viewing
- Locking mechanism (sensor to base)
- Variable sensitivity
- Electronically addressed
- Pulsing/non-pulsing controlled from panel*
- Addressed via TCH-B200 Hand Held Programmer
- Approved to MED, DNV, IEC 60092-504 requirements
- DNV-GL Module B (Type Examination)
- DNV-GL Module E (Product Quality Assurance)

Available with an integrated SCI: **ALN-ENM(SCI)**



ACC-ENM

An **Intelligent Multi Sensor** incorporating a thermal element and a High Performance photoelectric smoke chamber. Has three modes controlled from the Control Panel, allowing either the optical or thermal element or both to be active in making the fire decision.

STANDARD FEATURES

- User selectable modes
- Incorporates Optical & Heat elements
- Removable, High Performance Chamber
- Twin fire LEDs allow 360° viewing
- Pulsing/non-pulsing controlled from panel*
- Variable sensitivity
- Addressed via TCH-B200 Hand Held Programmer
- Approved to MED, DNV, IEC 60092-504 requirements
- DNV-GL Module B (Type Examination)
- DNV-GL Module E (Product Quality Assurance)

Available with an integrated SCI: **ACC-ENM(SCI)**



ATJ-ENM

An **Intelligent Multi-Heat Sensor** incorporating a variable Fixed Temperature heat element and Rate Of Rise heat element, both controlled from the Control Panel allowing either thermal element or both elements simultaneously to be active in making the fire decision.

STANDARD FEATURES

- User selectable modes
- Incorporates Fixed Temperature and Rate Of Rise Heat elements
- Twin fire LEDs allow 360° viewing
- Pulsing/non-pulsing controlled from panel*
- Addressed via TCH-B200 Hand Held Programmer
- LPCB & VdS approved to Classes A, B & C
- Approved to MED, DNV, IEC 60092-504 requirements
- DNV-GL Module B (Type Examination)
- DNV-GL Module E (Product Quality Assurance)

Available with an integrated SCI: **ATJ-ENM(SCI)**

YBN-R/3M



A **Marine Approved Common Mounting Base** which is fully compatible with Hochiki's ESP range of sensors. Supplied with square cable clamps for secure and reliable cable termination and is also capable of driving a remote LED if required.

STANDARD FEATURES

- Electronics free
- Supports ESP Marine Approved Sensors
- Takes 2.5mm² cables
- Slim profile - only 8mm
- Facility for remote indicator
- Quick Connection via square cable clamps
- Approved to MED, DNV, IEC 60092-504 requirements
- DNV-GL Module B (Type Examination)
- DNV-GL Module E (Product Quality Assurance)

Available with an integrated SCI: **YBN-R/3(SCI)M**

YBV-R/4M

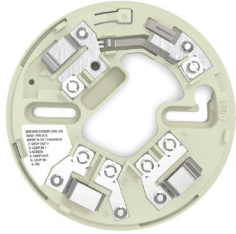

A **Marine SCI Sensor Mounting Base** which is fully compatible with Hochiki's ESP range of SCI sensors. It is supplied with square cable clamps for secure and reliable cable termination and is also capable of driving a remote LED if required.

STANDARD FEATURES

- Electronics free
- Stainless steel contacts
- Takes 2.5mm² cables
- Slim profile - only 8mm
- Facility for remote indicator
- Quick Connection via square cable clamps
- Also available in white
- Fourth terminal allows for SCI functionality of sensors

CHQ-DRC2/M(SCI)

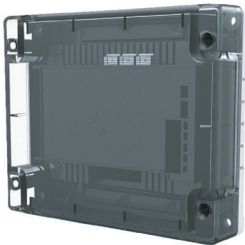

A **Marine Approved Intelligent Dual Relay Controller** designed to provide two general-purpose relay outputs, each output can be controlled independently and used to control dampers, plant and equipment shut-down. The monitored input can be used for local power supply fault monitoring or as a general-purpose input. The model features an integral short-circuit isolator.

STANDARD FEATURES

- Loop powered
- Single loop address
- Two independently controlled changeover relays
- Relays contact rated at 30 VDC at 1A
- Auxiliary monitored input
- Feature an integral short-circuit isolator
- Approved to MED, DNV, IEC 60092-504 requirements
- DNV-GL Module B (Type Examination)
- DNV-GL Module E (Product Quality Assurance)
- Can be used with CHQ-BACKBOX to comply with BS 7671

CHQ-DIM2/M(SCI)



A **Marine Approved Intelligent Dual Input Module** designed to interface to a variety of inputs such as door contacts, sprinkler flow/door switches and plant equipment. The model features an integral short-circuit isolator.

STANDARD FEATURES

- Loop powered
- Single loop address
- Each input can be configured to operate on either an open or short-circuit
- Features an integral short-circuit isolator
- Approved to MED, DNV, IEC 60092-504 requirements
- DNV-GL Module B (Type Examination)
- DNV-GL Module E (Product Quality Assurance)

CHQ-SZM2/M(SCI)

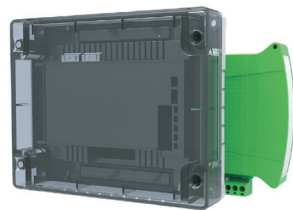

A **Marine Approved Intelligent Single Zone Monitor** designed to allow up to 6 conventional detectors or 3 DRD-EM to be interfaced to Hochiki's ESP analogue addressable system. The model features an integral short-circuit isolator.

STANDARD FEATURES

- Loop powered
- Up to 6 Conventional Detectors
- Single loop address
- Remote LED output
- Fully monitored for Short and Open Circuit faults
- Features an integral short-circuit isolator
- Approved to MED, DNV, IEC 60092-504 requirements
- DNV-GL Module B (Type Examination)
- DNV-GL Module E (Product Quality Assurance)
- Up to 3 DRD-EM Flame Detectors



CHQ-DSC2/M(SCI)

A **Marine Approved Intelligent Dual Sounder Controller** which has been designed to provide two sounder outputs (that can be driven separately) with full fault monitoring. The monitored input can be used for local power supply fault monitoring or as a general-purpose input. The model features an integral short-circuit isolator.

STANDARD FEATURES

- Single loop address
- Two independent sounder circuits
- Each circuit fully monitored for Open and Short Circuit faults
- Auxiliary monitored Input
- Outputs are synchronised and can be driven continuously or intermittently
- 24 VDC auxiliary power required
- Features an integral short-circuit isolator
- Approved to MED, DNV, IEC 60092-504 requirements
- DNV-GL Module B (Type Examination)
- DNV-GL Module E (Product Quality Assurance)
- Approved by LPCB

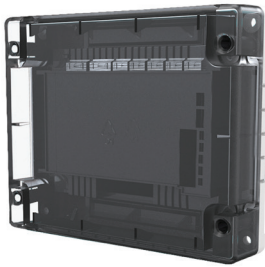

CHQ-DZM/M(SCI)

An **Analogue Dual Zone Monitor** that is a Dual Circuit Zone Controller designed to allow up to 60 conventional detectors (30 on each zone) to be interfaced to Hochiki's ESP analogue addressable system. The unit also features a Schottky Diode line continuity option, when used in conjunction with the optional LCMU.

Full monitoring against malfunction or disconnection, together with a selftest feature through the ESP protocol, ensuring the integrity of the CHQ-DZM/M(SCI) at all times. The CHQ-DZM/M(SCI) utilises simple DIL switches for reliable addressing.

STANDARD FEATURES

- Single Loop Address
- Supports two independent zones of conventional detectors
- Both zones fully monitored for short/open circuit
- Requires an auxiliary 24 VDC supply
- DNV-GL Module B (Type Examination)
- DNV-GL Module E (Product Quality Assurance)

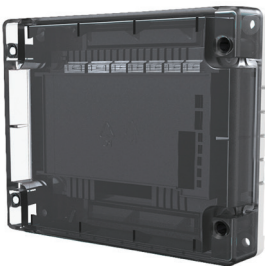

CHQ-DZM/M(SCI)-IS

An **Analogue Dual Zone Monitor** which is fully compatible with Hochiki's ESP analogue addressable protocol and I.S. equipment. The module will allow connection of up to 40 Hochiki I.S. conventional detectors (20 per zone) through a Galvanic isolator, which are fully monitored for open and short circuit. The unit also features an integral short-circuit isolator.

STANDARD FEATURES

- Single Loop Address
- Supports two independent zones of conventional detectors
- Both zones fully monitored for short/open circuit
- Requires an auxiliary 24 VDC supply
- DNV-GL Module B (Type Examination)
- DNV-GL Module E (Product Quality Assurance)



CHQ-SIM/M

An **Intelligent Single Input Module** designed to allow a single monitored input to be connected to the ESP loop. This provides a compact, low-cost option where the installation of the larger CHQ "Smart-Fix" Range of Modules might be difficult.

STANDARD FEATURES

- Includes a single monitored input
- Small design for simple provision of a monitored input onto an ESP loop
- DNV-GL Module B (Type Examination)
- DNV-GL Module E (Product Quality Assurance)



HCP-EM(SCI)

A **Marine Approved Intelligent Manual Call Point** fully compatible with Hochiki's ESP analogue addressable protocol and featuring an integral short-circuit isolator (SCI). Features a bi-coloured LED to indicate either fire (red) or short-circuit (amber). Also features plug-in wiring terminals for easy installation.

STANDARD FEATURES

- Fast response
- Status LED
- Non-frangible element fitted as standard (conforms to EN54)
- Addressed with TCH-B200 Hand Held Programmer & PL-3 lead
- Surface or flush mounting
- Approved to MED, DNV, IEC 60092-504 requirements
- DNV-GL Module B (Type Examination)
- DNV-GL Module E (Product Quality Assurance)
- Approved by LPCB



HCP-WM(SCI)

A Marine Approved Intelligent Weatherproof Manual Call Point fully compatible with Hochiki's ESP analogue addressable protocol and featuring an integral short-circuit isolator (SCI). Features a bi-coloured LED to indicate either fire (red) or short-circuit (amber). Also features plug-in wiring terminals for easy installation.

STANDARD FEATURES

- Fast response
- Integral short-circuit isolator
- Bi-colour status LED
- Non-frangible element fitted as standard (conforms to EN54)
- Addressed with TCH-B200 Hand Held Programmer & PL-3 lead
- Surface mounting
- LPCB Approved to EN54
- Approved to MED, DNV, IEC 60092-504 requirements
- DNV-GL Module B (Type Examination)
- DNV-GL Module E (Product Quality Assurance)
- IP67 rated

MARINE APPROVED (CONVENTIONAL)

Hochiki's Marine Approved Conventional range of products has been designed around the existing world-proven CDX range. All products have been approved for marine use by either Lloyds Register or Germanischer Lloyd and are ideal for use on ships, oil and gas platforms, wind farms etc.



SOC-E3NM

A Conventional Photoelectric Smoke Detector which is fully compatible with the majority of existing conventional systems.

STANDARD FEATURES

- Removable, High Performance chamber
- Automatic Sensitivity Window Verification (ASWV) – Drift Compensation Technology
- Wide voltage range (12 ~ 30 VDC)
- Low profile design with one piece outer cover
- Single fire LED - 360° viewing
- Range of mounting bases
- Approved by LPCB
- Approved to MED, DNV, IEC 60092-504 requirements
- DNV-GL Module B (Type Examination)
- DNV-GL Module E (Product Quality Assurance)



DCD-AE3M

A Conventional Rate of Rise Heat Detector incorporating a 60°C fixed temperature element. The thermistor and linearising circuit provide an accurate linear response Heat Detector. A third terminal provides integral remote indicator output.

STANDARD FEATURES

- Electronic linear heat detection
- Remote Indicator output
- Wide voltage range (9.5 ~ 30 VDC)
- Twin fire LEDs allow 360° viewing
- Range of mounting bases
- Approved by LPCB & VdS
- Approved to MED, DNV, IEC 60092-504 requirements
- DNV-GL Module B (Type Examination)
- DNV-GL Module E (Product Quality Assurance)



DCD-CE3M

A Conventional Rate of Rise Heat Detector incorporating a 90°C fixed temperature element. The thermistor and linearising circuit provide an accurate linear response Heat Detector. A third terminal provides integral remote indicator output.

STANDARD FEATURES

- Class 1 performance as defined in BS EN54-10:2002 (range up to 25m)
- Single IR technology
- Robust and slim design
- Low current consumption
- Easy to install
- Fits Y BN-R/6M
- Twin LEDs for 360° view
- Approved by LPCB & VdS
- Approved to MED, DNV, IEC 60092-504 requirements
- DNV-GL Module B (Type Examination)
- DNV-GL Module E (Product Quality Assurance)



DRD-EM

A Marine Approved Conventional Flame Detector designed for internal use to detect large flames. The detector fits the CDX marine-approved standard mounting base (YBN-R/6M). The detection zone is a 90° cone and the detection range is up and including 25m.

STANDARD FEATURES

- Class 1 performance as defined in BS EN54-10:2002 (range up to 25m)
- Single IR technology
- Robust and slim design
- Low current consumption
- Easy to install
- Fits Y BN-R/6M
- Twin LEDs for 360° view
- Approved by LPCB & VdS
- Approved to MED, DNV, IEC 60092-504 requirements
- DNV-GL Module B (Type Examination)
- DNV-GL Module E (Product Quality Assurance)

YBN-R/6M



A **Marine Approved Conventional Mounting Base** supplied with square cable clamps for secure and reliable cable termination but the base does not provide line continuity during detector removal, therefore if Call Points are being used then these should be wired onto the zone first. The integrated third terminal provides remote indicator output.

STANDARD FEATURES

- Integral remote indicator output
- Low Profile, only 8 mm
- Rugged design
- Quick connections via square cable clamps
- Accepts 2.5 mm² cables
- Bayonet slot, low insertion force for detectors
- Approved to MED, DNV, IEC 60092-504 requirements
- DNV-GL Module B (Type Examination)
- DNV-GL Module E (Product Quality Assurance)

MCP1A



A **Conventional Marine Approved Manual Call Point** based upon the industry standard KAC world series housing. The unit can support either a 'Frangible Glass' element or a 'Non Frangible Plastic' element. It is also supplied complete with SR-BACKBOX for surface mounting.

Note - Yellow version not EN54 compliant

STANDARD FEATURES

- Approved to EN54-11:2001
- Other colours available on request
- Approved by LPCB
- Terminals can accommodate up to a 2.5mm² solid conductor
- Approved to MED, DNV, IEC 60092-504 requirements
- DNV-GL Module B (Type Examination)
- DNV-GL Module E (Product Quality Assurance)

WCP1A



A **Conventional Marine Approved Weatherproof Manual Call Point** based upon the industry standard KAC world series housing and features easy to install, push-fit wiring terminals. The unit features a 'Non Frangible Plastic' element and a weatherproof Housing to IP67, which means it can be mounted in the most severe environmental conditions without water ingress.

Note - Yellow version not EN54 compliant

STANDARD FEATURES

- Complies with EN54-11
- Push-fit terminals can accommodate up to a 2.5mm² solid conductor
- Other colours available on request
- IP rated to IP67
- Approved to MED, DNV, IEC 60092-504 requirements
- DNV-GL Module B (Type Examination)
- DNV-GL Module E (Product Quality Assurance)

Equipment

Hochiki's comprehensive range of ancillary equipment includes products to help make routine maintenance and commissioning of analogue and conventional smoke detectors easier and more reliable. The range includes head removal tools, heat detector tester poles, loop commissioning and emulation equipment and duct smoke detection equipment.



DH-24

An **Electromagnetic Door Holder** designed to hold open fire doors and is ideally suited for hospitals, schools and other public buildings. In a fire situation the doors can be released automatically via a connection to the fire alarm system or manually by activating the release button.

STANDARD FEATURES

- 24 VDC
- Surface mounted
- 200 Newton holding force
- Swivel keeper plate
- Spring-loaded ejector pin
- Manual release button



SDP-3

A **Duct Probe Housing** allowing a standard photoelectric smoke detection device, either a conventional detector or an analogue sensor, to be mounted on the outside of an air duct for the purpose of monitoring the air within the duct.

STANDARD FEATURES

- One-tube air sampling system
- Test hole on cover
- Simple installation/maintenance
- Sensitive flow indication
- Installer-friendly connection of cables
- Allows air duct sampling using standard detector or sensor
- Fits either square or round section ducting (with additional brackets)



TCH-B200

A **Hand Held Address Programmer** designed to address the ESP range of Sensors and other intelligent devices such as the YBO-BS Base Sounder. Designed to be light, robust and easy to use, it operates from a single PP3 size battery which can provide up to 8000 operations.

STANDARD FEATURES

- Lightweight design
- Quick and reliable addressing
- Up to 8000 address settings from one battery
- Displays sensor analogue value

Note: Button colour may vary



1800-101 TT²

The **Flame Detector Test TT²** is a tester and calibration unit explicitly designed to work with the full range of Flame Detectors.

STANDARD FEATURES

- Used to test UV, UV/IR, UV/IR², UV/IR³ flame detectors, in-situ
- 8m testing range
- Can calibrate flame detectors (with kit - sold separately)
- Integral rechargeable battery



YBN-UA

A **Recess Mounting Adaptor** for both the ESP and CDX Range of sensors and detectors and their associated mounting bases. Allows a base and head combination to be flush mounted by providing a recess fixing to the ceiling.

(Shown with base fitted - not supplied)

STANDARD FEATURES

- Sturdy construction, easy to install
- Allows base and analogue sensor or conventional detector to be flush mounted
- Supplied with fixing brackets
- Colour-matched to existing ivory-coloured sensor/detector ranges
- Suitable for a maximum ceiling thickness of 30mm



YBD-RA

A **Surface Wiring Adaptor** which allows the majority of Hochiki Sensors/Detectors and their Mounting Bases to be fitted flush against a fixing surface, whilst also allowing surface wiring (without conduit) to be connected.

STANDARD FEATURES

- Low profile - only 16mm
- Compatible with the majority of existing Analogue and Conventional bases
- Colour matches standard Hochiki Analogue and Conventional sensor / detector / base ranges

SOLO POLES

Fibreglass Poles designed to be completely interchangeable with all of the SOLO tools. Manufactured in a lightweight fibreglass, the poles are completely non-conductive and have been subjected to rigorous conductivity testing to ensure the integrity of the insulating qualities.

STANDARD FEATURES

- Lightweight, non conductive
- Accept all of the SOLO tools
- Can extend to 9m

TESTIFIRE 1000

A **Smoke/Heat Head Unit**. Testifire 1000 is a technologically advanced, fully portable device for functional testing of detectors.

STANDARD FEATURES

- Faster, more productive testing with just one tool
- Simultaneous stimuli (smoke and heat) can cut test times in multisensors by up to 66%
- Stimuli capsules for smoke held within unit
- Powered by battery batons within pole
- Clearing cycle provides rapid detector reset with no repeat alarm
- Heat detector test times reduced through enhanced deployment of heat and wider range of temperature settings

SOLO 200

A **Universal Detector Removal Tool** suitable for the majority of current Hochiki detectors

*Except those with flying leads, for example the DFG-60E or the ACB-EW

STANDARD FEATURES

- Colour-coded grips twist into place to create different size combinations
- Universal, counterbalanced joint ensures the tool remains horizontal

TESTIFIRE 2000

A **Smoke/Heat/CO Detector Tester**. Testifire 2000 is a technologically advanced, fully portable device for functional testing of fire detectors.

STANDARD FEATURES

- Faster, more productive testing with just one tool
- Simultaneous stimuli (smoke and heat) can cut test times in multisensors by up to 66%
- Stimuli capsules for smoke and CO held within unit
- Powered by battery batons within pole
- Clearing cycle provides rapid detector reset with no repeat alarm
- Heat detector test times reduced through enhanced deployment of heat and wider range of temperature settings

SOLO 330

A **Smoke Detector Tester** providing functional testing to introduce (simulated) smoke or CO through the detector vents and into the sensing chamber.

STANDARD FEATURES

- Robust, lightweight design
- Touch sensitive, ideal for suspended ceilings
- Clear cup allows view of detector LED
- Spring-loaded dispenser mechanism conserves aerosol
- Test gas canisters (non CFC) are available containing either simulated smoke (for testing smoke detectors) or CO (for testing CO detectors).



SOLO 461

A **Cordless Heat Detector Tester** which utilises **Cross Air Technology** to ensure the correct temperature is applied to the sensing elements, not the detector plastics.

STANDARD FEATURES

- Safe, cable free, battery-powered operation
- Supplied with 2 Battery Batons™ and a fast charger
- Intelligent device, only heats when detector present



SOLO 823 KIT

An **Universal Set of Tools** for testing and removing smoke and heat detectors up to 9m high.

STANDARD FEATURES

- 1 x Solo 100 Telescopic Pole
- 3 x Solo 101 Extension Pole
- 1 x Solo 200 Universal Detector Removal Tool
- 1 x Solo 330 Aerosol Smoke Dispenser
- 1 x Solo 461 Cordless Heat Detector Test Kit (includes 2 Battery Batons™ and Charger)
- 1 x Solo 610 Protective Carrying Bag



SMB-1

An **IP66 Rated, Grey (RAL7035) Enclosure** designed for use with the Hochiki range of Modules. Supplied with a transparent black lid as standard. Used in conjunction with the SMB-ADAPTOR this enclosure can house any of the PCB assemblies from the Hochiki Smart-Fix Module range.

STANDARD FEATURES

- 32 knock-outs
- Grey lid available SMB-1(LID)
- Quick-release screws Polyurethane gasket provides IP66 protection
- Temperature resistance to +70°C, Impact resistant, and Non-flammable
- Corrosion free, resistant to most alkaline and acid



SMB-2

An **IP66 Rated, Grey (RAL7035) Enclosure** designed for use with the Hochiki range of DIN Modules. Supplied with a transparent black lid as standard. The unit is supplied with a DIN Rail section (plus fixings) and will accept up to six Hochiki DIN Rail Modules, side-by-side.

STANDARD FEATURES

- Quick-release screws
- Polyurethane gasket provides IP66 protection
- 32 knock-outs
- Supplied with DIN Rail and fixings
- Grey lid available SMB-2(LID)
- Temperature resistance up to +70°C, Impact resistant, and Non-flammable
- Corrosion free, resistant to most alkaline and acid
- Designed to house up to 6 Hochiki DIN Modules



SMB-3

A **Grey (RAL7035) Enclosure** designed for use with the Hochiki range of DIN Modules. Supplied with a transparent black lid as standard. The unit is supplied with a DIN Rail section (plus fixings) and will accept up to four Hochiki DIN Rail Modules, side-by-side.

STANDARD FEATURES

- 20 knock-outs
- Quick-release screws
- Polyurethane gasket provides IP66 protection
- Supplied with DIN Rail and fixings
- Grey lid available SMB-3(LID)
- Temperature resistance up to +70°C, Impact resistant, and Non-flammable
- Corrosion-free, resistant to most alkaline and acid
- Designed to house up to 4 Hochiki DIN Modules



PL-3

Additional Programming Lead 3 Way Connection, for use on Hochiki devices that feature the square programming terminal, HCP-E(SCI) call points for example. The jack plug fits into the socket on the TCH-B200 programmer and the square programming plug fits to the device.

STANDARD FEATURES

- Allows connection of TCH-B200 programmer
- For use with Hochiki devices with square connector

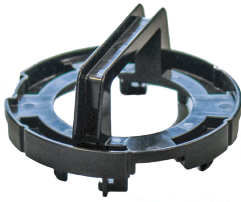

REMOVAL TOOL-3

Outer Cover Removal Tool allows the case of any photoelectric sensor or detector to be removed easily, even if the locking tabs have been employed. This allows easy access to the photoelectric chamber for maintenance or replacement. Fits ALN-EN, ACC-EN and ATJ-EN only.



CHQ-BACKBOX

The **Module Backbox** is designed for installations where the CHQ Range of Modules - CHQ-DIM(SCI), CHQ-SZM(SCI), CHQ-DZM(SCI), CHQ-DSC(SCI), CHQ-MRC(SCI), CHQ-DRC(SCI) & CHQ-PCM require mounting within a glanded enclosure. The unit features ten knock-outs suitable for cable glands (not supplied) and accepts the CHQ Modules directly as a lid.

STANDARD FEATURES

- Provides glanded cable connections
- Robust design
- Compatible with all CHQ Modules



CHQ-ADAPTOR

Adaptor for the New CHQ Modules designed to allow the “Smart-Fix” range of CHQ Modules to be housed in existing enclosures originally designed for the first generation CHQ-OEM Modules by modifying the ‘footprint’ of the unit.

STANDARD FEATURES

- Footprint matches older enclosure sizes
- Allows the PCB component of a CHQ Module to be housed in an enclosure



MBB-2

A **Marine Back Box** providing a splash proof and secure fixing for the Hochiki ESP and CDX Marine Approved Range of Sensors and Detectors and their associated Bases. Provides an aesthetically pleasing solution where surface fixed devices are required. The housing supports four 20mm glanded entries for cabling access.

STANDARD FEATURES

- 4 Glanded cable entry holes (glands not supplied)
- Colour matched
- Approved Sensor and Base range
- Provides moisture and dust resistant fixing
- Ideal for bulk-head fixing
- Approved to MED by GL
- GL Type approval
- Non-marine use version available (SBB-2)



SI-CAP2

A **Protective Cap** which can be fitted to the YBO-R/SCI isolator base range, the YBO-BS base sounder or the YBO-BSB base sounder beacon when either of these devices isn't fitted with a sensor. It can also fit the YBN-R/3 and the YBN-R/3(SCI).

STANDARD FEATURES

- Easy to Fit (Twist-fit)
- Protects Wiring Terminals on Isolator Bases and Base Sounders

HOCHIKI ASIA PACIFIC OFFICES ACROSS ASIA PACIFIC

HOCHIKI ASIA PACIFIC PTE. LTD.

82 Ubi Ave 4,
#06-02 Edward Boustead Centre,
Singapore 408832

+65 6841 9728
sales@hochikiasiapacific.com
<https://www.hochikiasiapacific.com>

HOCHIKI HO CHI MINH REPRESENTATIVE OFFICE

3rd Floor Rubicon Building,
74 Luong Dinh Cua Street,
An Khanh Ward, Thu Duc City,
Ho Chi Minh City, Vietnam

+84 28 3636 6806
sales@hochikiasiapacific.com
<https://www.hochikiasiapacific.com>

HOCHIKI JAKARTA REPRESENTATIVE OFFICE

Mid Plaza 2, 8th Floor,
Jalan Jenderal Sudirman Kav 10-11,
Karet Tengsin, Kecamatan Tanah Abang,
Kota Jakarta Pusat Daerah Khusus
Ibukota Jakarta 10220, Indonesia

+6221 5700078
sales@hochikiasiapacific.com
<https://www.hochikiasiapacific.com>

HOCHIKI (THAILAND) COMPANY LIMITED

BB Building, 10th Floor,
Unit 1011 54 Sukhumit 21,
Kwaeng Klong Toey Nua Khet Wattana
Bangkok 10110, Thailand

+66 (0) 2664 4445
info@hochiki.co.th
<https://www.hochikiasiapacific.com>

HOCHIKI HANOI REPRESENTATIVE OFFICE

Room No. 802, 8th Floor, CEO Building
Pham Hung Street, Me Tri Ward,
Nam Tu Liem District,
Ha Noi City, Vietnam

+84 28 3636 6806
sales@hochikiasiapacific.com
<https://www.hochikiasiapacific.com>

HOCHIKI MANILA REPRESENTATIVE OFFICE

Unit No.509 FSS Building II,
No. 18 Scout Tuason Corner,
Scout Castor Streets, Brg, Laging Handa,
Quezon City, Metro Manila, Philippines

+63 2 83658112
sales@hochikiasiapacific.com
<https://www.hochikiasiapacific.com>

HEADQUARTER

HOCHIKI CORPORATION

10-42 Kamiosaki 2-Chome
Shinagawa-Ku
Tokyo 141-8660
Japan

+81-(3)-3444-4111
overseas@hochiki.co.jp
<https://www.hochiki.co.jp>





HOCHIKI

World Class Leaders in Fire Detection Since 1918

Hochiki reserves the right to alter the specifications of its products from time to time without notice. Although every effort has been made to ensure the accuracy of the information contained in this document, it is not warranted or represented by Hochiki to be a complete and up-to-date description. Check online for current version.

HOCHIKI ASIA PACIFIC

82 Ubi Ave 4 #06-02 Edward Boustead Centre Singapore 408832
T: +65 6841 9728 | E: sales@hochikiasiapacific.com | W: www.hochikiasiapacific.com

