

# 244NX / 244NX-R / 244NX-RC Exploded Spares

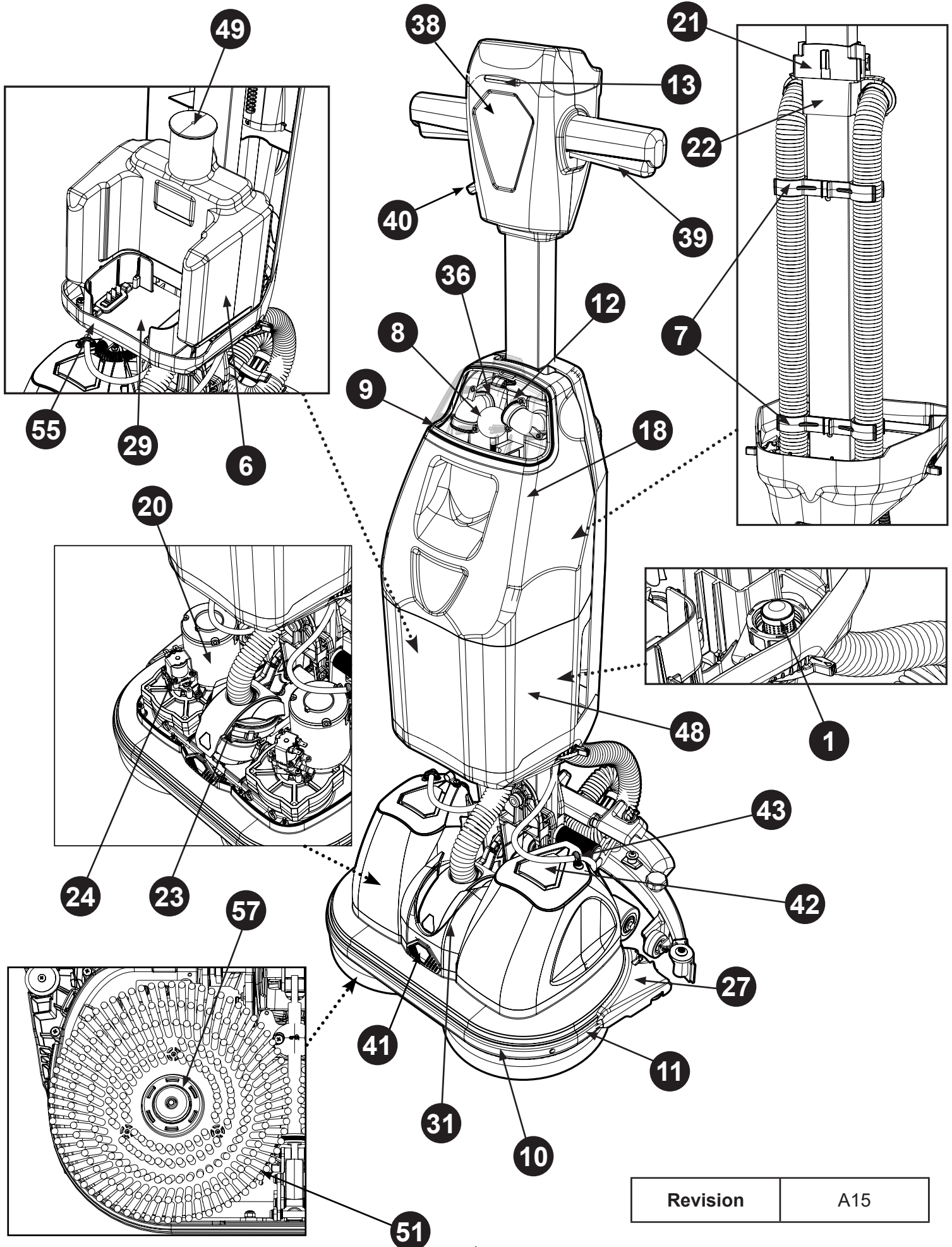

Compact and Cordless Scrubber Dryer



Revision	A15
----------	-----

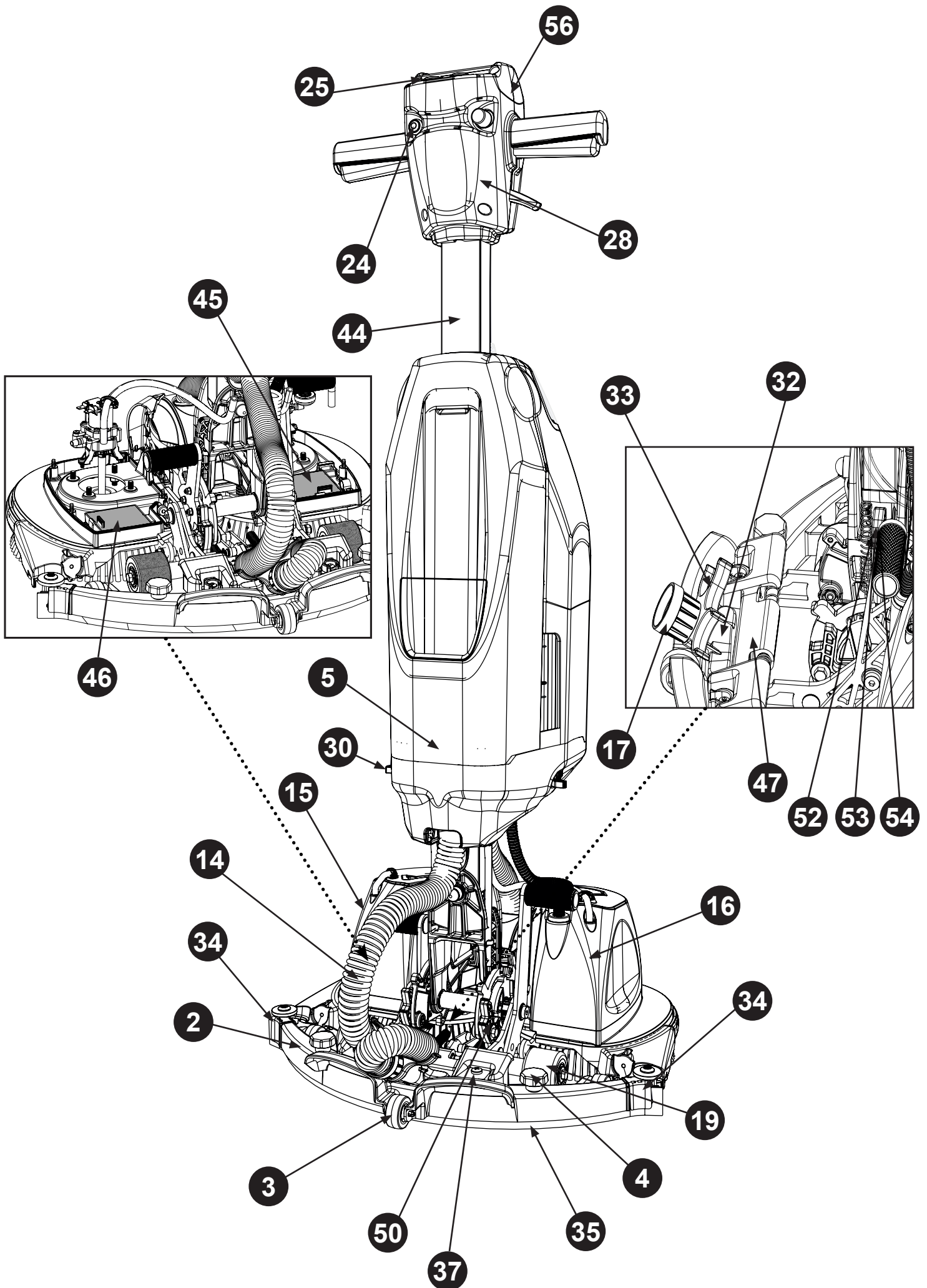

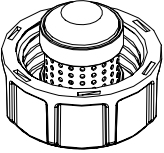
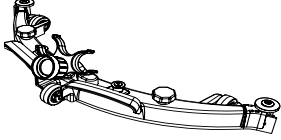
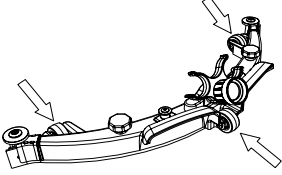
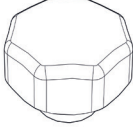
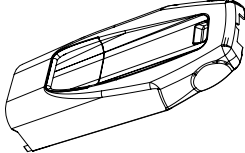
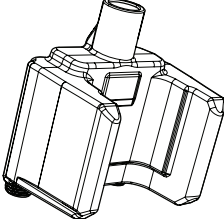
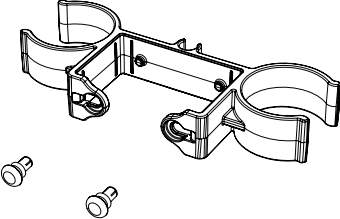
Item Number	Image Reference	Item Description	Part Number	Item Quantity
1		Clean Water Tank Valves	913829	2
2		NUC244NX Squeegee Assembly	913830	1
		NUC244NX-R Squeegee Assembly	918636	
3		Squeegee Wheel Set	913831	3
4		Squeegee Retaining Knob	913832	2
5		NUC244NX Rear Cover Assembly	913842	1
		NUC244NX-R Rear Cover Assembly	918654	
6		Clean Water Tank	913825	1
7		Dual Hose Clip	918074	1

Item Number	Image Reference	Item Description	Part Number	Item Quantity
8		Ball Shut Off Assembly	913835	1
9		Separator Assembly	913837	1
10		NUC244NX Deck Buffer Kit	913838	1
		NUC244NX-R Deck Buffer Kit	918654	
11		NUC244NX Trim Glide	913839	2
		NUC244NX-R Trim Glide	918656	
12		Port Filter Disc	913840	5
13		Handle Protection Strip	913841	2
14		Replacement Hose	913828	1

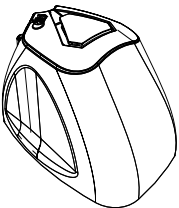
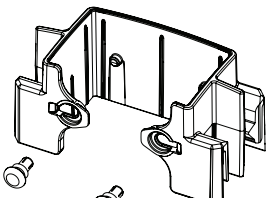
Item Number	Image Reference	Item Description	Part Number	Item Quantity
15		NUC244NX Left Motor Cover Moulding	913843	1
		NUC244NX-R Left Motor Cover Moulding	918646	
16		NUC244NX Right Motor Cover Moulding	913845	1
		NUC244NX-R Right Motor Cover Moulding	918647	
17		Hose Cuff	913846	1
18		NUC244NX Waste Water Tank Kit	913827	1
		NUC244NX-R Waste Water Tank Kit	918637	
19		Rear Wheel Kit	914004	2
20		Brush motor Kit (Left or Right)	913990	1
21		Tank Lock Clip	918060	1
22		Hose End Clip	918064	1

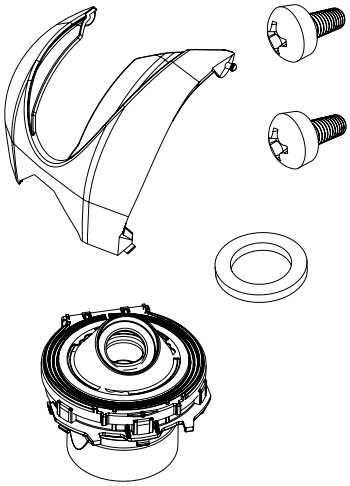
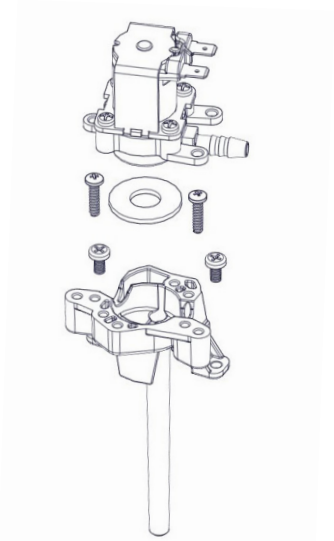
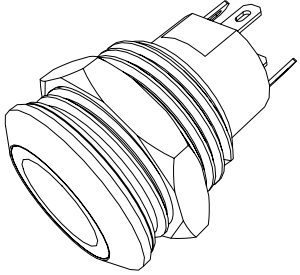
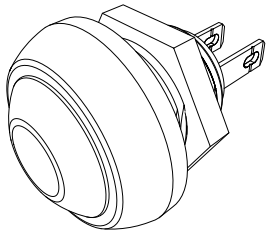
Item Number	Image Reference	Item Description	Part Number	Item Quantity
23		VAC Motor Kit	913992	1
24		Solenoid Kit (Left or Right)	913994	1
25		Handle VAC/Water Switch Kit	913996	1
26		Handle Safety Switch Kit	913998	1

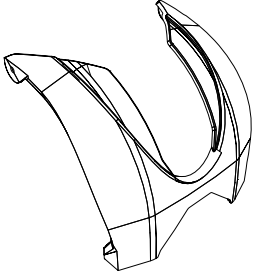

Item Number	Image Reference	Item Description	Part Number	Item Quantity
27		NUC244NX Deck Wing Kit	914000	1
		NUC244NX-R Deck Wing Kit	918638	
28		NUC244NX Handle PCB Kit	914006	1
		NUC244NX-R Handle PCB Kit	918639	
29		Battery/Control PCB Kit	914008	1
30		Tap Assembly Kit	914010	1
31		NUC244NX Center Cover Moulding	914002	1
		NUC244NX-R Center Cover Moulding	918765	

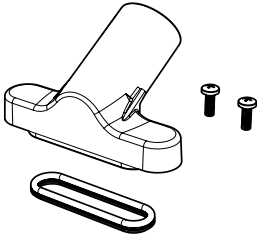
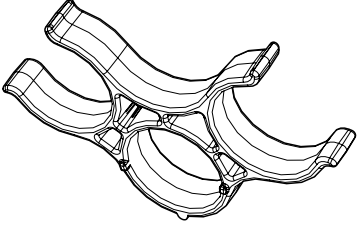
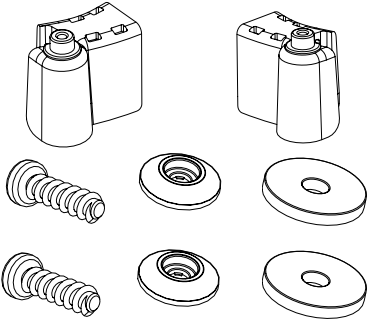
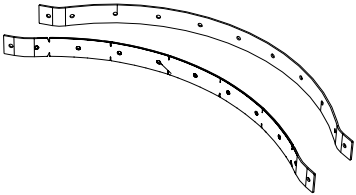
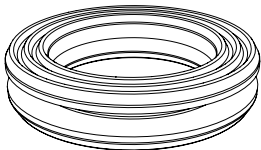
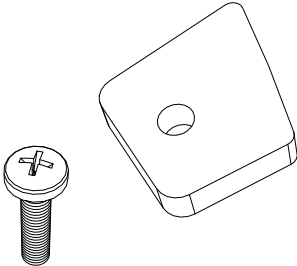
Item Number	Image Reference	Item Description	Part Number	Item Quantity
32		NUC244NX Floor Tool Trap Moulding Kit	914144	1
		NUC244NX-R Floor Tool Trap Moulding Kit	918648	
33		Floor Tool Trap Clip	914143	1
34		Floor Tool End Caps (Left or Right)	914145	1
35		Blade Set (Front & Rear)	913810	1
36		Gasket Seal	914741	4
37		Floor Tool Snap Plate	915857	2

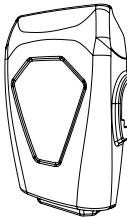
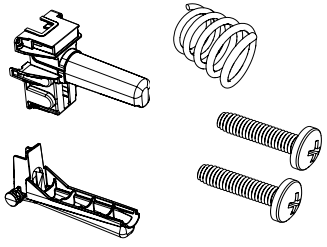
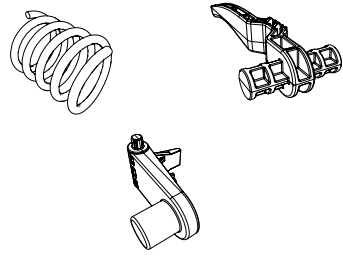
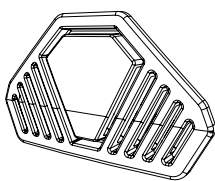
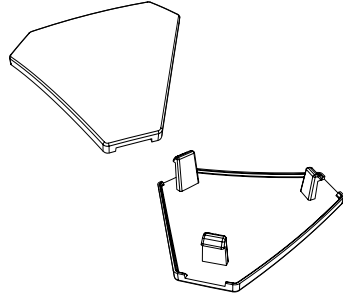
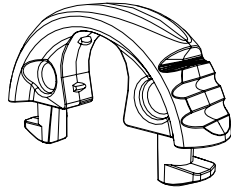

Item Number	Image Reference	Item Description	Part Number	Item Quantity
38		NUC244NX Handle Front Cover Moulding	914445	1
		NUC244NX-R Handle Front Cover Moulding	918640	
39		NUC244NX Handle Grip and Trigger Kit	914457	1
		NUC244NX-R Handle Grip and Trigger Kit	918641	
40		Handle Adjust and Release Control Kit	914447	1
41		NUC244NX Grill Moulding Kit	914444	1
		NUC244NX-R Grill Moulding Kit	918649	
42		NUC244NX Motor Vent Cover Kit	914455	2
		NUC244NX-R Motor Vent Cover Kit	918650	
43		NUC244NX Replacement Tube Clip Kit	914452	4
		NUC244NX-R Replacement Tube Clip Kit	918651	

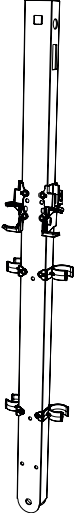
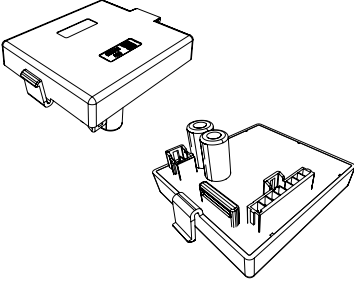
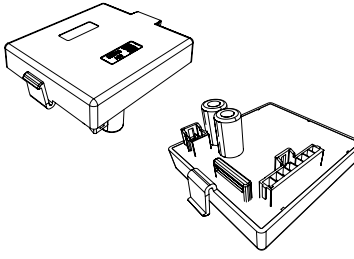
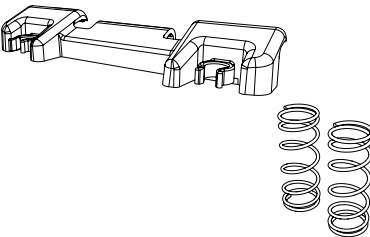
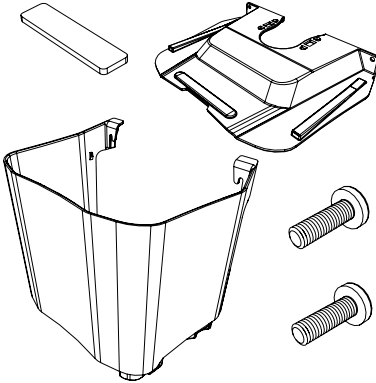
Item Number	Image Reference	Item Description	Part Number	Item Quantity
44		Handle Tube Kit	914463	1
45		Motor Controller Right Kit	914449	1
46		Motor Controller Left Kit	914451	1
47		NUC244NX Floor Tool Bracket Kit	914443	1
		NUC244NX-R Floor Tool Bracket Kit	918642	
48		NUC244NX Water Tank Support Kit	915562	1
		NUC244NX-R Water Tank Support Kit	918652	

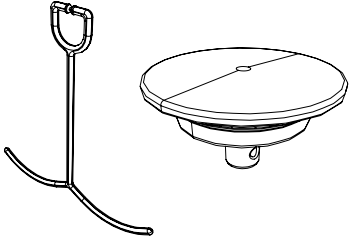
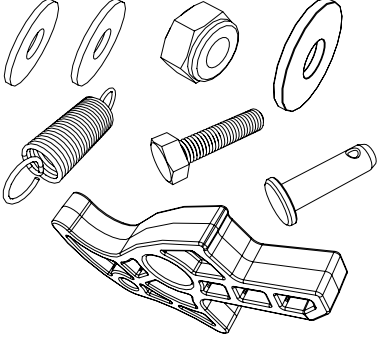
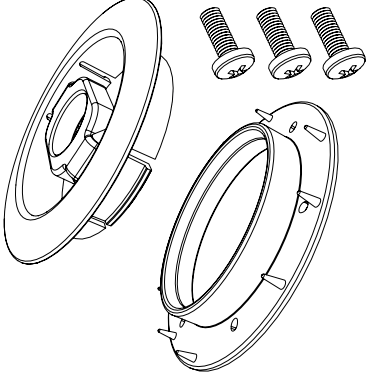
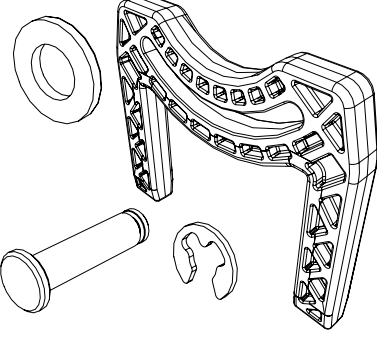
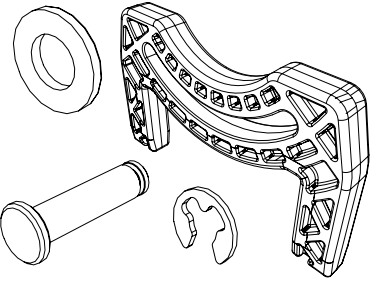
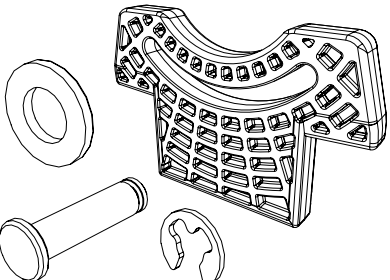
Item Number	Image Reference	Item Description	Part Number	Item Quantity
49		Clean Water Tank Cap Kit	915563	1
50		Floor Tool Latching Kit	915585	2
51		Drive Board Padlock Clip with Clip Centre Moulding Kit	915564	1
52		Pitch Latch Kit	915575	1
53		Update Pitch Latch Kit (55mm Version)	918070	1
54		Update Pitch Latch Kit (126mm Version)	919151	1

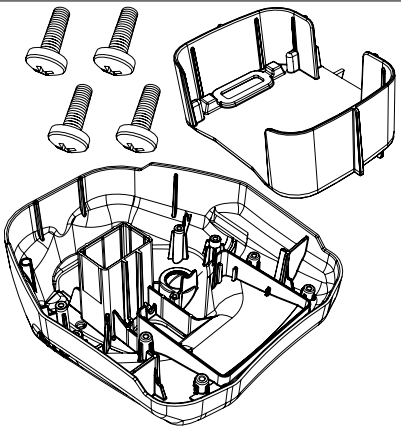
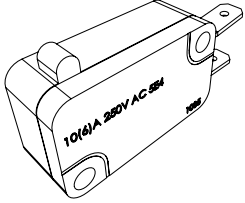
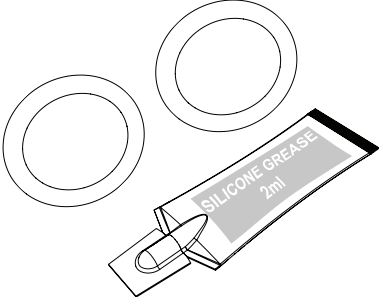
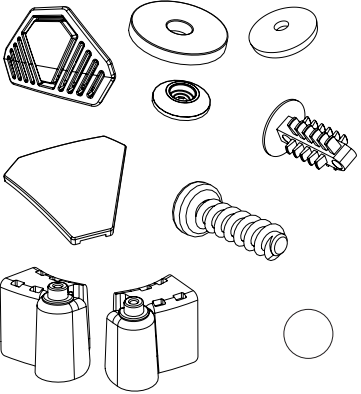
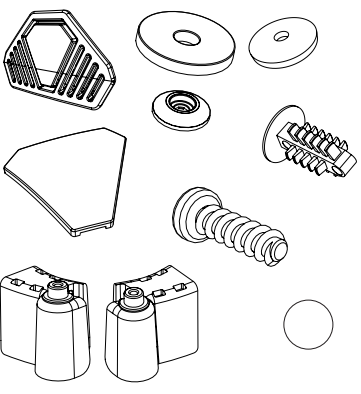
Item Number	Image Reference	Item Description	Part Number	Item Quantity
55		NUC244NX Battery and Base Support Moulding Kit	915576	1
		NUC244NX-R Battery and Base Support Moulding Kit	918653	
56		Snap Action Switch Kit	915577	2
57		O-Ring Kit	915735	1
58		Red Colour Coding Kit	915109	1
59		Blue Colour Coding Kit	915110	1

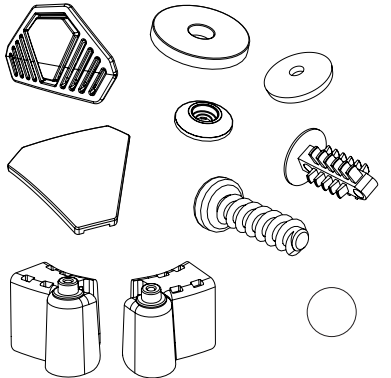
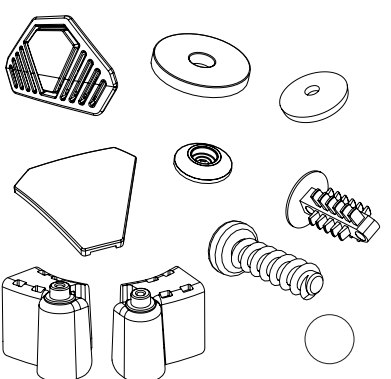
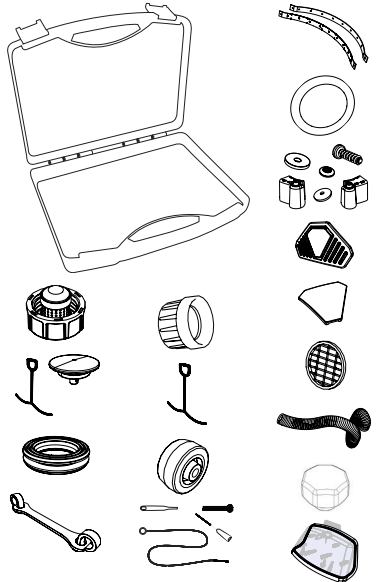
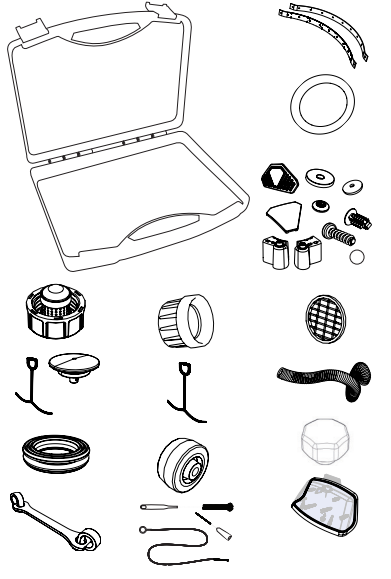
Item Number	Image Reference	Item Description	Part Number	Item Quantity
60		Green Colour Coding Kit	915111	1
61		Yellow Colour Coding Kit	915112	1
62		NUC244NX Maintenance Kit	916038	1
63		NUC244 Maintenance Kit (McDonalds)	916046	1

**EN**

Any maintenance operation is to be carried out in a safe environment  
All electrical work is to be carried out by a competent person  
Move tank assembly  
Retain all nuts, screws and washers for refitting (if applicable)

**DE**

Sämtliche Wartungsarbeiten sind in einer sicheren Umgebung durchzuführen  
Alle Elektroarbeiten sind durch eine entsprechend befähigte Person durchzuführen  
Bewahren Sie alle Muttern, Schrauben und Unterlegscheiben zum Wiedereinbau sicher auf (falls zutreffend)

**FR**

Toute opération d'entretien doit être effectuée dans un environnement sécurisé  
Tous travaux électriques doivent être assurés par du personnel qualifié uniquement  
Déplacez l'ensemble réservoir  
Conservez tous les écrous, vis et rondelles en vue d'un (éventuel) remplacement

**NL**

Alle onderhoudswerkzaamheden moeten worden uitgevoerd in een veilige omgeving  
Alle elektrische werkzaamheden moeten worden uitgevoerd door een bevoegd persoon  
Verplaats de hoofdtank  
Bewaar alle moeren, schroeven en sluitringen voor hermontage (indien van toepassing)

**PT**

Qualquer operação de manutenção deve realizar-se num ambiente seguro  
Todo o trabalho eléctrico deve ser realizado por um técnico qualificado  
Mover o depósito principal  
Guardar todas as porcas, parafusos e anilhas para reinstalar (se aplicável)

**IT**

Tutti gli interventi di manutenzione devono essere effettuati in un ambiente sicuro  
Tutti gli interventi elettrici devono essere effettuati da personale competente  
Spostamento del gruppo serbatoio  
Conservare tutti i dadi, le viti e le rondelle per il rimontaggio (se applicabile)

**ES**

Toda operación de mantenimiento debe realizarse en un entorno seguro  
Todo trabajo eléctrico debe ser realizado por una persona competente  
Mover el conjunto de depósito  
Guardar todas las tuercas, tornillos y arandelas para volver a colocarlos (si corresponde)

**PL**

Wszystkie czynności konserwacyjne należy wykonywać w bezpiecznym środowisku  
Wszelkie prace elektryczne powinna wykonywać osoba kompetentna  
Przesunąć zespół zbiornika  
Zachować wszystkie nakrętki, śruby i podkładki do ponownego montażu (jeżeli dotyczy)

**SV**

Alla former av underhåll ska utföras i en säker miljö  
Allt elektriskt arbete ska utföras av en behörig person  
Flytta tankenheten  
Behåll alla muttrar, skruvar och brickor för reparation (om det är tillämpligt)

**FI**

Kaikki huoltotoimenpiteet on suoritettava turvallisessa ympäristössä  
Ammattitaitoisen henkilön on tehtävä kaikki sähkötyöt  
Siirrä säiliöyksikkö  
Säilytä kaikki mutterit, ruuvit ja prikat asennusta varten (jos käyttökelpoisia)

**DA**

Enhver form for vedligeholdelsesarbejde skal udføres i et sikkert miljø  
Alt elektrisk arbejde skal udføres af en kompetent person  
Flyt tankenheden  
Gem alle møtrikker, skruer og skiver til genmontering (hvis relevant)

