

NRV 240-11

NRV 370-11

NRV 380-11

NRV 470-11

EVR 370-11

NSR 240-11

NRV 240-11 (110 Volt)

NRV 370-11 (110 Volt)

# Numatic

numatic.com

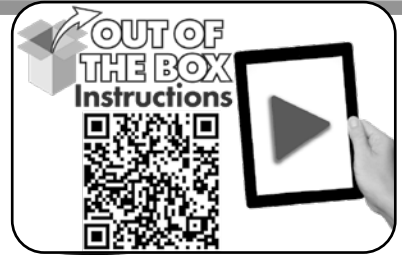

## Original Instructions

CAUTION, Read the Instructions before using the machine.

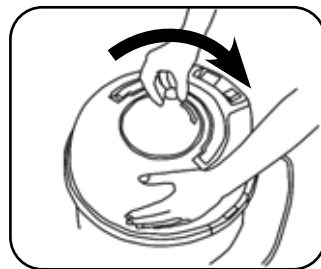
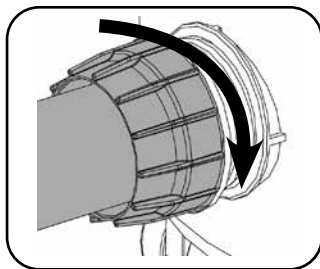
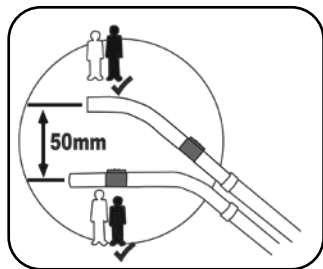
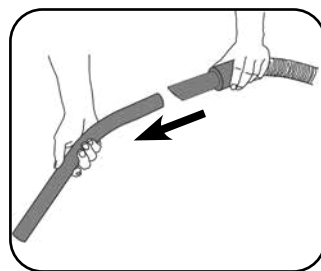
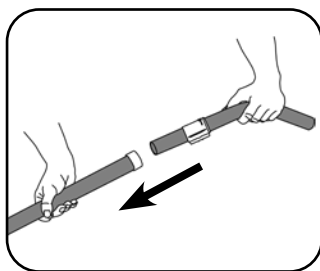
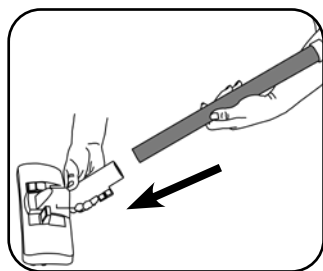
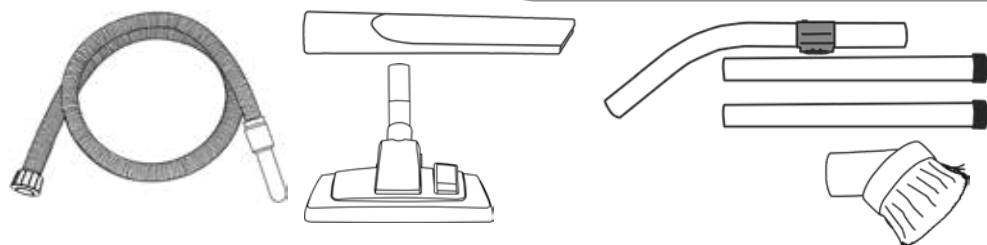
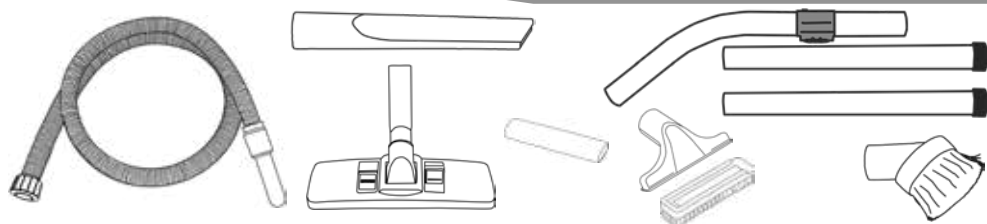
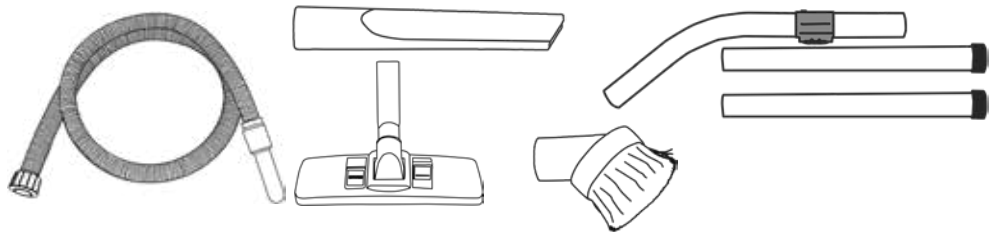

Start

Power On Indicator Light

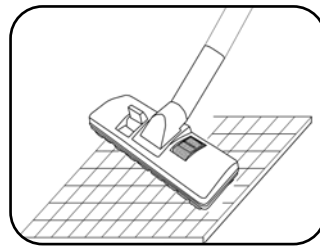
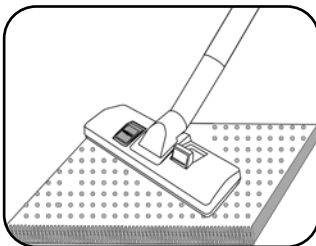
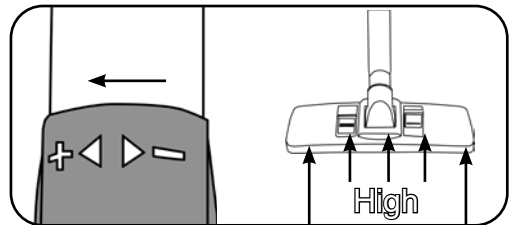
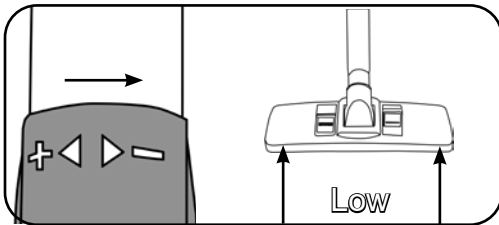
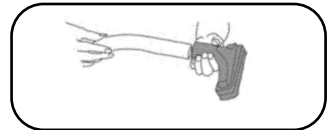
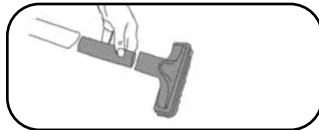
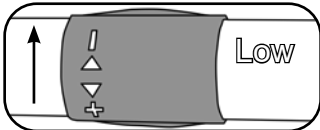
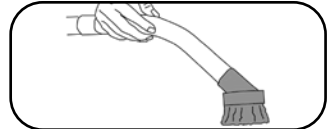
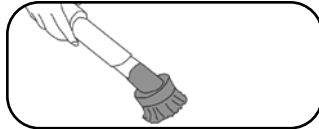
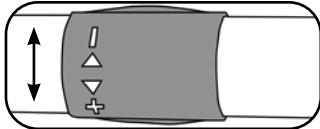
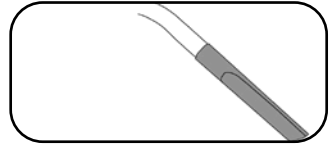
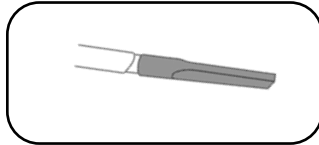
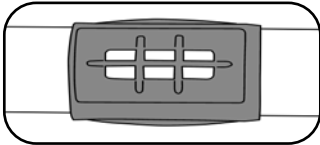
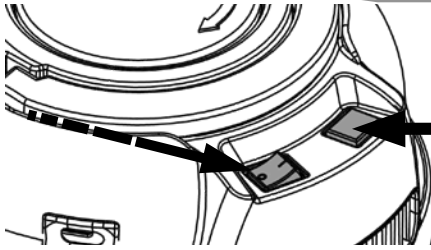

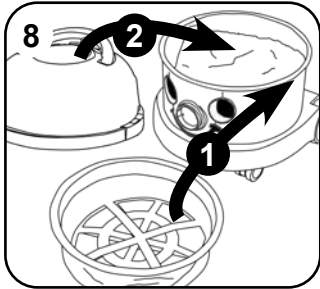
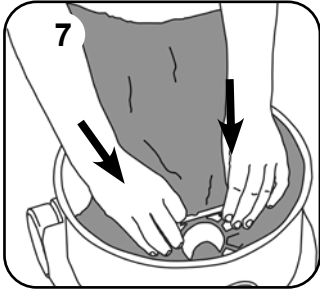
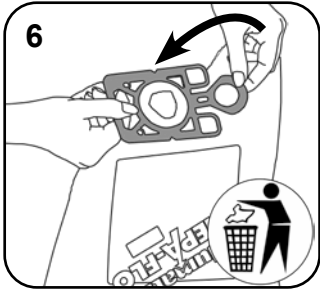
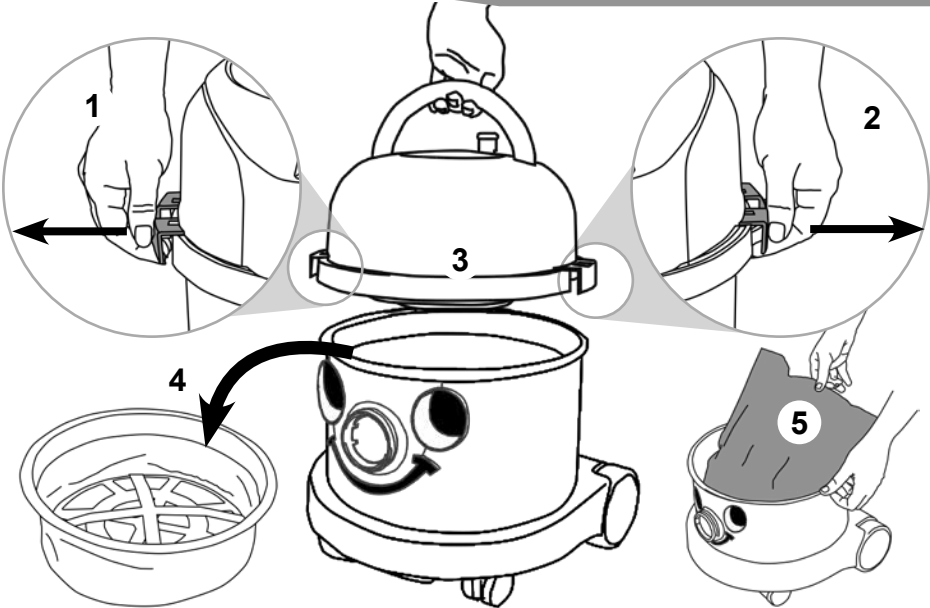

EVR 370-11 Only  
Cleaning the Tool Head

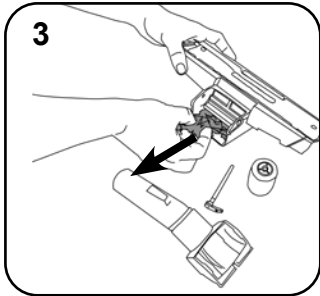
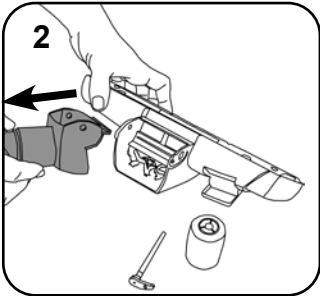
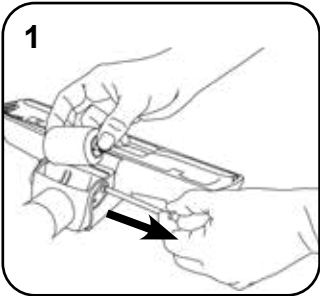

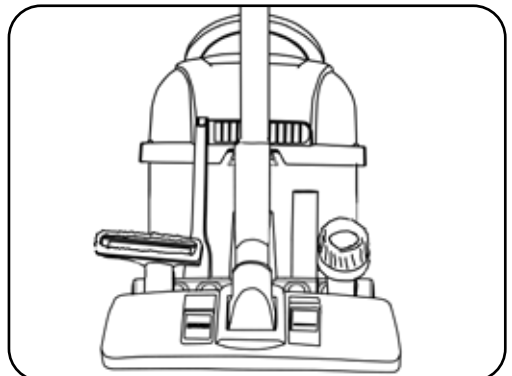
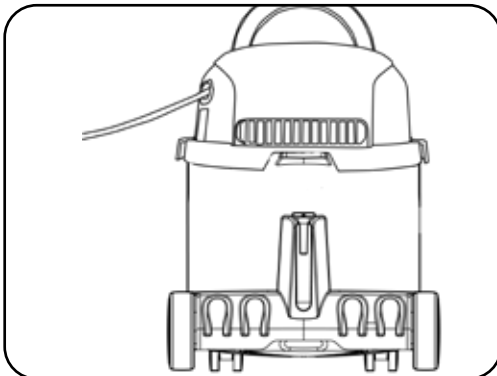
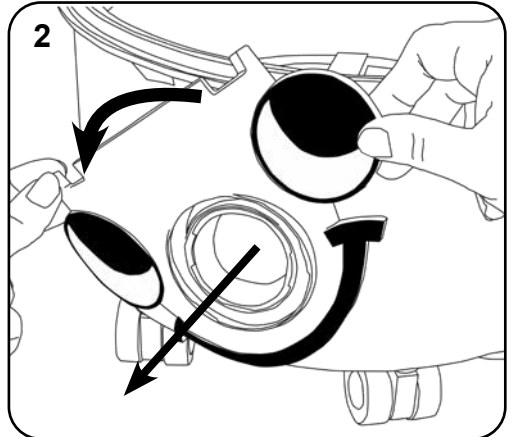
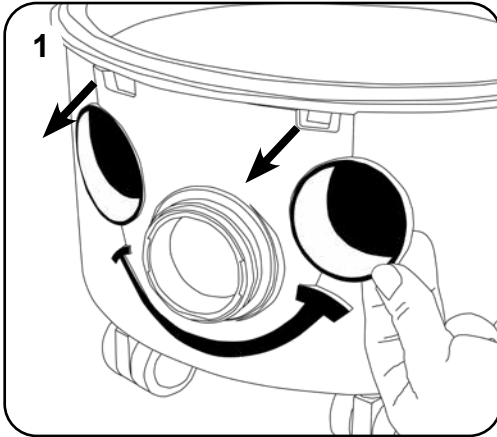
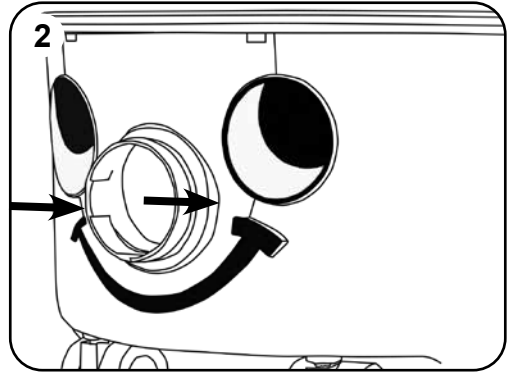
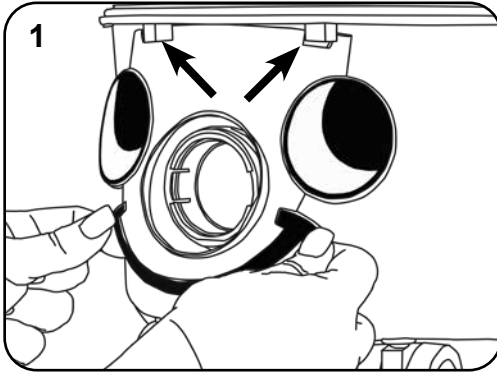

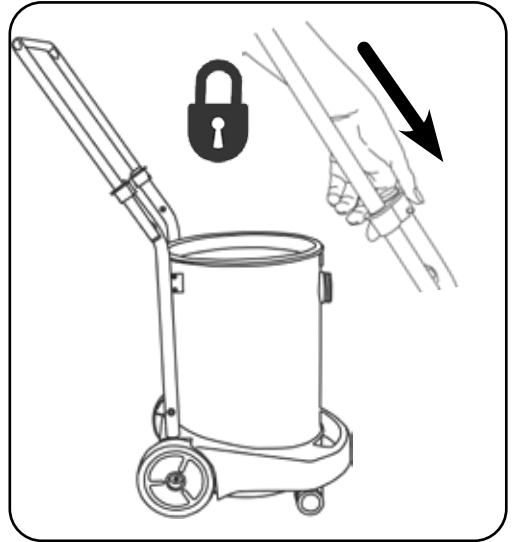
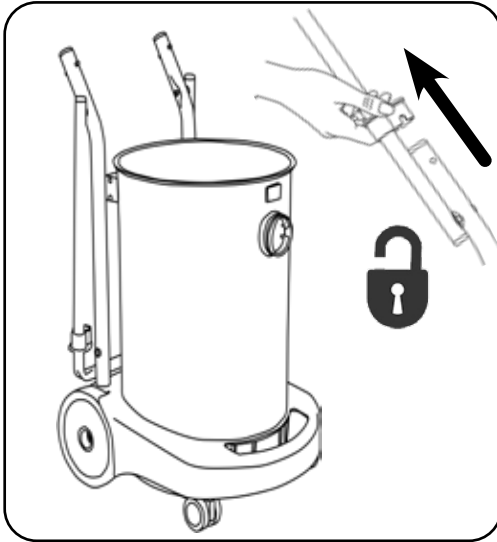

Data

	1	2	3	4	5	6
NRV/NSR 240	9 L	31.4 m	9.0 kg	LpA ≤ 70 dB(A)	Class II	360 mm x 370 mm x 415 mm
NRV 370	15 L		9.1 kg			360 mm x 370 mm x 510 mm
NRV 380	15 L		9.1 kg			355 mm x 355 mm x 485 mm
NRV 470	27 L		11.6 kg			358 mm x 450 mm x 710 mm
EVR 370	15 L	26.8 m	9.1 kg			360 mm x 370 mm x 510 mm

1	2	3	4	5	6
Drum Size	Cleaning Range	Weight (Ready to work)	Sound Pressure	Protection Class	Dimensions

Replacement parts

TriTex Filter	
604165	TriTex-Filter
HepaFlo Bags	
604015	NVM 1CH (Pack of 10) 240 Drum Size
604016	NVM 2BH (Pack of 10) 370 / 380 Drum Size
604018	NVM 3AH (Pack of 10) 470 Drum Size

1	Company Name & Address
2	Model
3	Voltage / Alternating Current
4	Frequency
5	Rated Input Power
6	Weight
7	WEEE Logo
8	Protection Class 2 Symbol
9	Approval Mark
10	Machine yr/wk Serial Number

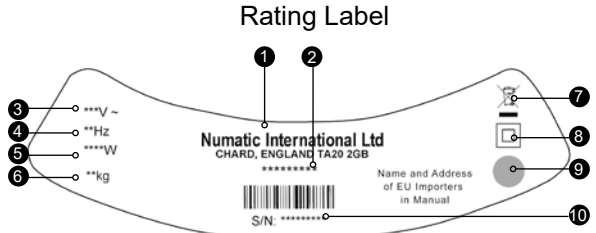

<h2>Maintenance</h2>
<p><b>Daily</b></p> <p>Keep the machine clean, including hoses and tubes.          Ensure the bag and filter are fitted.          Regularly examine the power cord.          Check dust bag frequently.          Check filters are clean.</p> <p><b>Weekly - as daily and:-</b>          Check for any worn or damaged parts and replace immediately.</p>

**WEEE Legislation (Waste, Electrical and Electronic Equipment)**

Vacuum cleaner, accessories and packaging should be sorted for environmentally - friendly recycling.

**(Only for UK/EU Countries)**

Do not dispose of vacuum cleaner into household waste! According to the European Directive 2012/19/EU on waste electrical and electronic equipment and its incorporation into national law. Vacuum cleaners that are no longer suitable for use must be separately collected and sent for recovery in an environmentally - friendly manner.



<p><b>PPE (personal protective equipment).</b> That may be required for certain operations.</p>				
Ear Protection	Safety Footwear	Head Protection	Safety Gloves	
Eye Protection	Protective Clothing	Dust / Allergens Protection	Hi Viz Jacket	

**NOTE:** A risk assessment should be conducted to determine which PPE should be worn.

Failure to rectify the problem or in the event of a breakdown contact your Numatic dealer or the Numatic Technical helpline +44 (0)1460 269268

**Safety Critical Components**  
 (220-240 Volt) HO5-V2V2-F 12.5m x 2 Core x 0.75 mm<sup>2</sup>  
 (220-240 Volt) HO5-V2V2-F 12.5m x 2 Core x 1.00 mm<sup>2</sup>  
 (110 Volt) HO5-V2V2-F 10m x 2 Core x 1.50 mm<sup>2</sup> Yellow Cable + Industrial Plug

## **WARNING**

Read the instruction manual before using the machine.

Operators shall be adequately instructed on the use of their machine.

As with all electrical equipment, care and attention must be exercised at all times during use, in addition to ensuring that routine and preventative maintenance is carried out periodically to ensure safe operation.

Failure to carry out maintenance as necessary, including the replacement of parts to the correct standard could render this equipment unsafe and the manufacturer can accept no responsibility in this respect.

Maintenance should only be carried out by a qualified person.

This machine is for DRY USE only and must not be stored outside or used in wet conditions.

The machine shall be disconnected from the mains power by removing the plug from the power supply socket during cleaning or maintenance and when replacing parts or converting the machine to another function.

Only use the socket outlet on the machine for purposes specified in the instructions (if fitted).

This machine is not to be used by children or persons with reduced physical, sensory or mental capabilities, or lack of experience or knowledge.

This appliance is intended to be cleaned and maintained by an adult.

Children being supervised are not to play with the machine.

This machine is not a toy.

This machine is not suitable for picking up hazardous or explosive dust.

Contact your local distributor if you require a machine capable of performing these tasks.

## **CAUTION**

Ensure that the filtration system fitted to the machine is suitable for the material being collected.

This vacuum cleaner is intended for indoor use in the collection of dry materials.

This machine should be stored indoors only.

## **NOTES**

The primary use for this machine is commercial, for example in hotels, schools, hospitals, factories, shops and offices.

This product complies with the requirements of clause 20 of IEC/EN 60335-2-69 Stability and Mechanical Hazards.

This vacuum cleaner is fitted with a thermal protection device. If the vacuum cleaner stops working, remove the plug from the wall before investigating where the fault lies.

If the vacuum cleaner has a blockage, switch off, remove the plug from the power socket, inspect the floor tool, tubes and hose for debris. If the floor tool, tubes and hose are clear, replace the dust bag and clean the filter.

The vacuum cleaner should be inspected after use for damage.

The vacuum cleaner should be stored in a dry place.

When moving from one place to another, consider the weight of the machine.

## **DO**

- Keep your machine clean including hoses and tubes.
- Change dust bag frequently.
- Keep filters clean.
- Keep diffuser filter (where fitted) clean.
- Use filter bags, they will enhance performance and help keep machine clean.
- Use a Numatic Original filter bag under fine dust conditions.
- Keep hoses and tubes clear.
- Replace any worn or damaged parts immediately.
- Only use the brushes provided with the machine. The use of other brushes may impair safety.
- Regularly examine the power cord. If damage is found such as cracking or ageing the power cord must be replaced by a qualified person.
- Only replace the power cord with the correct Numatic approved replacement part.

## **DO NOT**

- Pull on the cable to unplug the machine from the power supply.
- Use to suck up hot ashes or lighted cigarette ends.
- Use steam cleaners or pressure washers to clean the machine or use in the rain.
- Immerse in water for cleaning.
- Attempt machine maintenance or cleaning unless the power supply plug has been removed from the supply outlet.
- Use in wet environments or to collect wet materials.
- Under any circumstances place foreign objects including (but not limited to) air fresheners, air freshener capsules or scented beads of any type into the top filter of the machine. Doing so can be dangerous and risk damage to the machine and may invalidate the machine warranty.





# Numatic International Warranty

Numatic International Limited warrant to the original purchaser that its products are free of defects in both material or workmanship for the period shown below:-

Homecare and Cleancare Vacuum cleaners.....	2 Years
Rotary Floor Machines.....	2 Years
Twintec Auto Scrubber Dryer.....	1 Year
Vario Ride-On Scrubber Dryer.....	1 Year / 1500 hours
Mopping, Compacts, Combi and Servocare Products.....	1 Year
Individual Accessories and Spare Parts.....	6 Months

*Note: This warranty expressly excludes consumable parts such as carbon brushes, floor brushes, mops, batteries etc, that are considered replaceable from time to time during the normal working life of the machine.*

*Using non Numatic dustbags can be detrimental to both machine performance and life and may invalidate the Warranty.*

- A. The warranty period commences from the date the goods are purchased.*
- B. All warranty claims must be processed through the Dealer from whom the equipment was purchased. The Dealer will co-operate with the purchaser throughout the warranty claims procedure and will arrange any necessary repairs using genuine Numatic parts.*
- C. If the original Dealer is no longer able to fulfil his obligations please contact Numatic International Limited with full details of the claim and proof of purchase so that this may be processed without delay.*
- D. Any warranty claim can only relate to the specific part that is proven to be at fault and for which a replacement will be supplied but cannot be extended to constitute a claim against the complete machine.*
- E. Numatic International will supply the Dealer with any warranty parts required, subject to the claim being validated, after return of the faulty items in accordance with Numatic International Limited's General Conditions of Sale.*
- F. Claims will not be accepted if they are the result of fair wear and tear, misuse or abuse of any kind.*
- G. No replacement will be given unless the appropriate evidence of the validity of the claim has been provided to the satisfaction of Numatic International Limited.*
- H. Numatic International Limited reserve the right to charge for any unnecessary work carried out as a result of an invalid claim.*
- I. No variation to this warranty may be made or implied by any member of Numatic International Limited or its Dealers unless such variation is in writing and authorised by the Company*

# Numatic

Numatic International Limited. Chard, Somerset, TA20 2GB

Telephone: 01460 68600 Fax: 01460 68458

© Numatic International Limited





numatic.com

**Numatic International Limited (Head Office)**

Chard, Somerset TA20 2GB, UNITED KINGDOM  
Tel: 01460 68600 numatic.com

**Numatic International GmbH**

Fränkische Straße 15-19, 30455 Hannover, DEUTSCHLAND  
Tel: +49 (0) 511 984 2160 numatic.de

**Numatic International Denmark**

Fränkische Straße 15-19, 30455 Hannover, DEUTSCHLAND  
Tel: +45 (0) 316 40808 numatic-online.dk

**Numatic International S.A.S**

13/17 rue du Valengelier, EAE la Tuilerie, 77500 Chelles, FRANCE  
Tel: +33 (0) 164 726 161 numatic.fr

**Numatic International BV**

Vennootsweg 15, 2404 CG, Alphen aan den Rijn, NEDERLAND  
Tel: +31 (0) 172 467 999 numatic.nl

**Numatic International Schweiz AG.**

Sihlbruggstrasse 3A, 6340 Baar, SCHWEIZ  
Tel: +41 (0) 41 768 0760 numatic.ch

**Numatic International (PTY) Ltd.**

Cnr. 16th & Pharmaceutical Road, Randjes Park, Midrand 1685, SOUTH AFRICA  
Tel: +27 (0) 861 686 284 numatic.co.za

**Numatic International ULDA**

Rua Francisco da Silva Duarte, n°79,  
4475-269 Santa Maria de Avioso, Castêlo da Maia, PORTUGAL  
Tel: +351 220 047 700 numatic.pt

**NUMATIC INTERNATIONAL SPAIN, S.L.U.**

Av. Baix Llobregat, 5-7, Oficina bajos 1 (Parc Negocis Mas Blau II),  
08820 El Prat de Llobregat (Barcelona) SPAIN  
Tel: +34 93 647 22 22 numatic.es

**Numatic International Italy S.R.L**

Via Luigi Galvani, 2, Z.I. Talponedo, 33080 Porcia (PN), ITALY  
Tel: +39 (0) 434 046 211 numatic.it

Specification subject to change without prior notice  
numatic.com © Numatic International Limited